

Troubleshooting Guide



CAUTION: Remove batteries from the machine before servicing.

Problem	Possible Source	Areas to check
Floor Machine will not run	No battery	Install a battery
	Low battery	Change / charge battery
	Motor butt joint is open	Insert the motor butt joint, tighten the nut.
Floor Machine bounces	Bad motor	Change motor
	Brush or pad holder not properly in place.	Place it properly. (See operating instructions.)
	Using brush on dry surface without dry shampoo or wet shampoo.	Apply necessary shampoo dry or wet.
	Using black carpet brush on berber or lowpile carpet.	Use white terrycloth bonnet instead.

FCT will repair or replace, free of charge, to the original purchaser, any part, which is found to be defective in material or workmanship within one (1) year of the date of purchase for all models. The Multi-Floor Machine is intended for commercial use.

Additional Warranty Information for all models

Components returned prepaid to an FCT Factory Authorized Service Center or to FCT will be repaired or replaced free of cost at the option of Fast and/or its service center when upon examination by either of them, such components are found to be defective.

Whenever calling, please be sure to have your model and serial number from data plate.

ALL OTHER SERVICING SHOULD BE DONE BY AN FCT AUTHORIZED SERVICE CENTER.

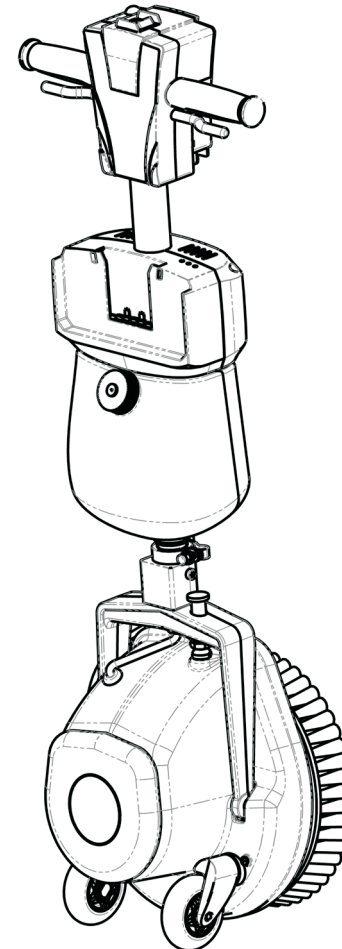

User's Manual  
**i-Scrub**<sup>30 em</sup> Pro-B  
 MULTI-FLOOR MACHINE

**IMPORTANT**

**SAVE THIS Manual!**

Includes:

- Safety Warnings
- Warranty
- Operating Instructions
- Trouble Shooting Guide
- Accessories

**BEFORE OPERATING  
CLEANER, READ ALL  
INSTRUCTIONS IN THIS  
MANUAL CAREFULLY.**

**Table of Contents**

IMPORTANT SAFETY INSTRUCTIONS .....2

Customer Service .....3

INTRODUCTION .....3

GETTING STARTED .....4

Machine setup .....4

Lock / unlock operation handle .....4

Attaching Accessories .....4

Removing Floor Machine On and Off .....5

Turning Floor Machine On and Off .....5

To Guide the Floor Machine .....5

CARPET & AREA RUG APPLICATION .....6

Dry Carpet Cleaning .....6

Bonnet Cleaning, VINYL AND LINOLEUM .....6

LAMINATE, VINYL AND LINOLEUM .....6

FLOOR APPLICATIONS .....6

Surface Cleaning .....6

Scrubbing .....6

Stripping .....6

Refinishing .....7

SEALED HARD WOOD FLOOR APPLICATIONS .....7

Surface Cleaning Sealed Floors .....7

WAXED HARD WOOD FLOOR APPLICATIONS .....8

TILE FLOOR APPLICATIONS .....8

Deep Cleaning .....8

Light Cleaning .....9

STONE FLOOR APPLICATIONS .....9

CONCRETE AND ASPHALT APPLICATIONS .....10

Removing Oil & Dirt .....10

ACCESSORIES .....10

General .....10

Bonnets .....10

Pads .....10

Brushes .....11

Sand Screens .....11

MAINTENANCE&TROUBLESHOOTING .....11

Care of your Fast Floor Machine .....11

User Maintenance .....11

Troubleshooting Guide .....12

**Safety &  
General Information**

**IMPORTANT  
SAFETY INSTRUCTIONS**

When using an electrical appliance, basic precautions should always be followed, including the following:

**READ ALL INSTRUCTIONS BEFORE USING THIS MULTI-FLOOR MACHINE**

**WARNING**  **To reduce the risk of fire, electric shock, or injury:**

- Use indoors only.
- Risk of explosion - Floor sanding can result in an explosive mixture of fine dust and air. Use floor sanding machine only in well ventilated area.
- Do not allow to be used as a toy. Close attention is necessary when used by or near children.
- Do not leave appliance unattended when plugged in. Unplug from outlet when not in use and before servicing.
- Use only as described in this manual. Use only manufacturer's recommended attachments.
- Do not use with a damaged cord or plug. If appliance is not working as it should, has been dropped, damaged, left outdoors, or dropped into water, return it to a service center.
- Do not pull or carry by cord, use cord as a handle, close door on cord, or pull cord around sharp edges or corners. Keep cord away from heated surfaces.
- Do not run cleaner over cord.
- Do not use on stairs.
- Connect to a properly grounded outlet only. See grounding instructions.
- Unplug before installing or removing pads/cleaning brushes.
- To reduce the risk of fire, use only commercially available floor cleaners and waxes intended for machine application.
- Do not unplug by pulling on cord. To unplug, grasp the plug, not the cord.
- Do not handle plug or cleaner with wet hands.
- Do not put any object into openings. Do not use with any opening blocked. Keep free of dust, lint, hair and anything that may reduce air flow.
- Keep hair, loose clothing, fingers and all parts of body away from openings and moving parts.
- Turn off all controls before unplugging.
- Do not use appliance in an enclosed space where flammable, explosive or toxic vapors are given off by oil base paint, paint thinner, some mothproofing substances, or in an area where flammable dust is present.

**Sand Screens**

Sand screens offer the very best in floor sanding. For all sand screens, place the black drive pad holder on Multi-Floor Machine. Then place the sand screen under any floor pad on floor and center Multi-Floor Machine onto the pad.



For Questions or Information about Fast's Line of Cleaning Products, Please Call or Visit Your Local Fast Dealer.

**Beige Marble Pad** (marble only)

- For restoring and cleaning marble floors.

To use a floor pad, see "Attaching Accessories" on page 4 and "Removing Accessories" on page 5.

- Strips linoleum, vinyl, laminate and tile floors.
- Cleans tile and grout.
- Can be used on commercial vinyl.
- Use on smooth concrete.
- Use with Sand Screens.
- Scrubs and cleans wood decks.

**Blue Scrub Pad** (medium aggressive)

- Used for scrubbing.
- Cleans tile and concrete.

**Brown Strip Pad** (most aggressive)

- Strips linoleum, vinyl, laminate and tile floors.
- Cleans and scrubs tile and grout.
- Can be used on commercial vinyl.
- Use on smooth concrete.
- Use with Sand Screens.
- Scrubs and cleans wood decks.

**Brushes**

Brushes are designed to get into grooves and recesses on non-flat surfaces. Brushes lift and remove ground-in dirt and grime.



Brushes are coded depending on how aggressive they are with the black carpet brush being the least aggressive, followed by the tan polish brush (union mix) and the orange scrub brush the most aggressive.

**Black Carpet Brush**

- (least aggressive)
- Use with Bissell Dry Shampoo.
- Safe, soft action needed for carpet cleaning.
- Use on textured linoleum.
- Use for cleaning delicate or glazed ceramic or porcelain tile.

**Tan Polish Brush (Union Mix)**

- (medium aggressive)
- Use to polish wood floors.
- Will "blend" in excess floor wax, maintain an even coat of wax and eliminate wax build-up.
- Use for getting inside cracks of a wood floor.
- Use to polish waxed wood floors.
- Use for marble, stone, and delicate tile floors.

**Orange Scrub Brush**

- (most aggressive)
- Used to clean ceramic tile or concrete and many tough stains.

To use a brush, see "Attaching Accessories" on page 4 and "Removing Accessories" on page 5.

**User Maintenance**

The motor bearings are factory lubricated and sealed. All other servicing should be performed by an authorized service center. There are no user serviceable parts inside bumper with damp cloth after each use. A little care will keep your looking like new.

This is a precision machine. Dropping, unreasonable bumping or rough handling may result in damage to the balanced counter-weight system. Wrap your cord loosely around the two hooks on the handle. Remove brushes after use. The bristles may be damaged due to the weight of the machine. Store your machine in the upright position. After each use, remove wax or cleaning solutions from the unit. After sanding, blow sawdust off motor. Clean housing and bumper with damp cloth after each use. A little care will keep your looking like new.

**Maintenance &  
Troubleshooting**

Care of your Fast Floor Machine

## Concrete and Asphalt Applications

### Removing Oil and Dirt

Absorbent Powder effectively and safely cleans concrete and asphalt without solvents. application is a natural mineral that absorbs and captures oil and dirt so it can be safely discarded or rinsed away.

#### Equipment and Material Required:

- Multi-Floor Machine
- Black Drive Pad Holder
- Absorbent Powder
- Brown Strip Pad
- Orange Scrub Brush

#### Procedure:

To clean oil, dirt, mold and mildew from smooth concrete, use the Absorbent Powder and the brown strippad. To clean rough or uneven concrete or asphalt, use Absorbent Powder and the orange scrub brush.

For fresh stains or spills that have not dried, use the Greaselock Absorbent Powder as a dry powder. For dry stains, add a little water during mixing or scrubbing stage.

Liberally apply Absorbent Powder to spill or area to clean, completely covering it. Allow five to ten minutes to absorb for fresh stains, overnight for dried stains.

Use the Multi-Floor Machine and brown strip pad or orange scrub brush to agitate the powder on the floor. Mop or hose off floor if necessary.

Absorbent Powder packaging for complete instructions.

## Accessories

Fast offers a full line of accessories to give you the tools you need for the job!

Depending on the unit purchased, some of the accessories below may be included with your Multi-Floor Machine. All of these accessories are available at our website,

When choosing different pads and brushes there is no exact science to selecting an accessory for a particular floor. Bonnets are good for surface cleaning most floor types. Pads are good for scrubbing and polishing flat surfaces. Brushes work well for getting into recesses in non-flat surfaces, like tile, where the bristles can get into grout lines. When you choose an accessory, remember you want one aggressive enough to do the job but gentle enough not to damage the floor. Use common sense. For example, do not use a brown strip pad (aggressive) on a wood floor (soft floor). Start with what is safe and move to a more aggressive accessory, if needed.

**Note:** Fast recommends removing brushes and pads when storing the Multi-Floor Machine. Accessories can become deformed if stored on the machine.

### General

#### Black Drive Pad Holder

- (Black plastic with teeth)
- Holds pads and bonnets in place



#### Bonnets

Bonnets are designed to surface clean most surfaces. They are washable and can be reused.



#### White Terrycloth Bonnet

- This bonnet cleans the traffic lane and spots in the carpet without wetting the entire carpet.
- Use with Fast Premist Pre-Spray and Dry Carpet Cleaner.
- When one side of bonnet is dirty, flip it over and use the other side.
- When job is complete, clean terrycloth bonnet in washing machine using cold water or hose off and allow to air dry.

#### Lamb's Wool Bonnet

- Designed to provide the best possible shine on wood, tile and vinyl floors.
- Use the bonnet for everyday buffing to remove scuff marks.
- When job is complete, clean lambs wool bonnet in washing machine using cold water or hose off and allow to air dry.

To use a bonnet, see "Attaching Accessories" on page 4 and "Removing Accessories" on page 5

### pads

Pads are designed to be porous and open-weave (except the beige pad) so that when it loosens dirt it can pick it up. The dirt goes inside the pad (i.e. off the floor). All pads can be turned over and the other side used before cleaning or disposing. Pads may be hosed off in some instances and re-used.



The pads are color coded depending on how aggressive they are (except for the beige marble pad): White is the softest, followed by blue medium aggressive, and brown being the most aggressive.

#### White Polish Pad

- (least aggressive)
- Apply paste wax.
  - Clean and polish wood (coated & uncoated), linoleum, and laminate.
  - Cleans all surfaces except stone.

Brushes, pads, drive blocks and other parts are subject to normal wear and are not covered by this limited warranty. This limited warranty does not apply to any part subjected to accident, abuse, alteration, misuse, damage caused by fire or act of God, the use of voltages other than indicated on the serial number plate of this product, or service of this product by other than FCT or an FCT Factory Authorized Service Center.

FCT does not authorize any person or representative to assume or grant any other warranty obligation in connection with the sale of this product.

FCT's limited warranty is valid only if you retain proof of purchase from FCT or an FCT authorized retail dealer of this product. If you purchase this product from any other source, your purchase is "AS IS" which means that FCT grants to you no warranty and that you, not FCT, assume the entire risk of the quality and performance of this product, including the entire cost of any necessary servicing or repairs of any defects.

FCT's liability for damages to you for any cost whatsoever, arising out of this statement of limited warranty shall be limited to the amount paid for this product at the time of original purchase, and FCT shall not be liable for any direct, indirect, consequential or incidental damages arising out of the use or inability to use this product.

Some jurisdictions do not allow the exclusion or limitation of incidental or consequential damages, so the above limitation or exclusion may not apply to you.

ALL EXPRESS AND IMPLIED WARRANTIES FOR THIS PRODUCT, INCLUDING IMPLIED WARRANTIES OF MERCHANTABILITY AND FITNESS FOR A PARTICULAR PURPOSE, ARE LIMITED IN DURATION TO THE WARRANTY PERIOD, AND NO WARRANTIES, WHETHER EXPRESS OR IMPLIED, WILL APPLY AFTER THIS PERIOD.

This warranty gives you specific legal rights and you may have other rights which vary from jurisdiction to jurisdiction.

### Customer Service

Your FCT floor cleaner is a product of precise engineering. If you require additional information or have problems with your FCT appliance, you may call FCT customer service at:

Please specify the model number and serial/code number which can be found on the data plate on the side of the Orbiter Multi-Floor Machine.

Save your sales or purchase slip. Should your FCT appliance require warranty service in the U.S.A., present this slip to the Authorized Service Center as your proof of purchase date or, in Canada, call customer service.

## INTRODUCTION

The Easy Motion Multi-Floor Machine is the most advanced, easiest to use machine of its kind. With proper care and use, Easy Motion Multi-Floor Machine will last a lifetime. This booklet will tell you how to care for the Multi-Floor Machine and all about its features, accessories and their uses.



**CAUTION: CAUTION:** Remove batteries from the machine before servicing. For more information see the "Maintenance and Troubleshooting" section.

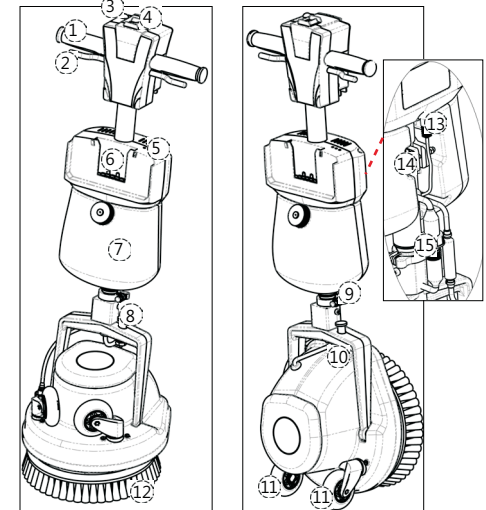

Working position

Storage / Transportation position

- |                      |                          |                      |
|----------------------|--------------------------|----------------------|
| 1. Operation handle  | 7. Water tank            | 13. Pump adaptor     |
| 2. Control rod       | 8. Indexing plunger      | 14. Tank hook        |
| 3. Pump push switch  | 9. Handle clip           | 15. Motor butt joint |
| 4. Power switch      | 10. Locking block        |                      |
| 5. Indicating lights | 11. Transportation wheel |                      |
| 6. Battery slot      | 12. Brush / Pad / bonnet |                      |

\* : There are 2 kinds of operation handles. Long handle for common use, short handle (optional) for stairs cleaning.

The transportation wheels have 2 positions. You can easily change the 2 positions by 3 steps.

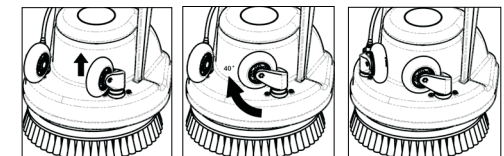

1. Pull the wheel out of its base.
2. Rotate the wheel to the target position wheel is locked. (40 deg.).
3. Release it till the

## GETTING STARTED

Your Multi-Floor Machine comes completely assembled and ready to operate once the proper accessories are attached. The on/off switch has international symbols (O) Off and (I) ON.

### Machine setup

Before using, take the scrubbing head and handle out of the packaging box, following a few steps below to set up the machine.

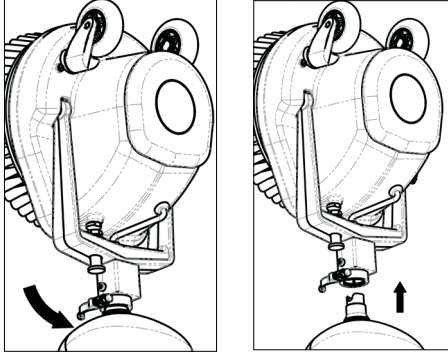

1. Put the handle into the tube clip housing.

2. Lock the handle with the clip handle.

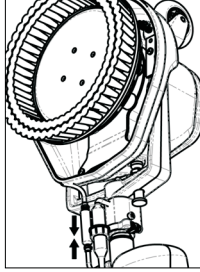

3. Insert the motor but joint, tighten the nut.

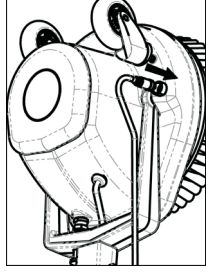

4. Insert the hose adapter into the joint.

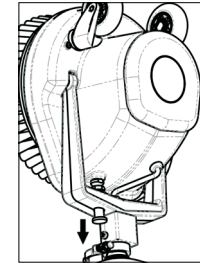

Pull the handle of the indexing plunger to unlock. Rotate the handle downward to lock it automatically.

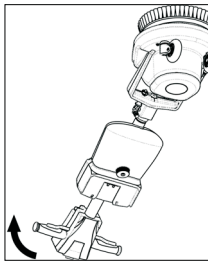

## ENGLISH

### Attaching Accessories

The Easy Motion Multi-Floor Machine can be used on almost any surface with the right accessories. A complete list and description of the available accessories is included on page 10 under "Accessories".

To attach a pad, bonnet, or sand screen:

1. Lay the Multi-Floor Machine on its back with the handle lying on the floor.
2. Attach the pad or bonnet to the black drive pad holder using the teeth of the black drive pad holder. If attaching a sand screen, first attach the pad to the black drive pad holder. Then place the sand screen on the floor-side of the pad.
3. Place the black drive pad holder on the beige holder (See Figure below).
4. Set the Multi-Floor Machine upright with the pad, bonnet, or sand screen sitting on the floor.

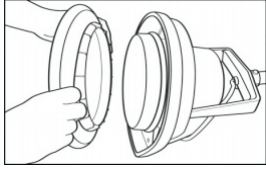

To attach a brush:

1. Lay the Multi-Floor Machine on its back with the handle lying on the floor.
2. With the bristles pointed away from the unit, place the brush on the beige holder pan found on the bottom of the Multi-Floor Machine (See Figure above).
3. Set the Multi-Floor Machine upright with the brush sitting on the floor.



**CAUTION:** NEVER put the brush or black drive pad holder on the machine by placing it on the floor and moving the running machine over it, or by placing the machine over the brush or black drive pad holder and then starting the motor.

To install a battery:

1. Put the machine on the floor at the storage / transportation position, turn off the power switch.
2. Grab the battery (Not included in the package) by the handle and put it into the battery slot (See Figure below).
3. Make sure the battery clip fully lock the battery in the slot.

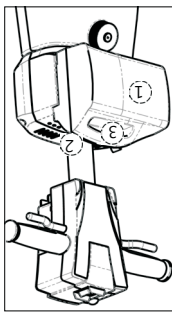

## ENGLISH

### Light Cleaning

#### Equipment and Material Required:

- Multi-Floor Machine
- White Terrycloth Bonnet
- Tile Floor Cleaner

#### Procedure:

The Floor Cleaner lifts dirt, grime and grease from tile floors and grout, leaving sparkling results.

- Dilute Tile Floor Cleaner according to the instructions on the bottle.
- Lightly spray a 6 ft by 6 ft area with Tile Floor Cleaner.
- Clean with the Multi-Floor Machine and white terrycloth bonnet. This bonnet is designed to lift and remove dirt from hard surfaces.

### Deep Cleaning

For cleaning all types of stone floors, including marble, granite, slate and other stone floors.

#### Equipment and Material Required:

- Multi-Floor Machine
- Tan Polish Brush (Union Mix)
- Stone Floor Cleaner
- Vacuum, Broom or Dust Mop
- Mop and Bucket

Stone Floor Cleaner is a pH neutral balanced daily cleaner designed to safely clean all stone surfaces without damaging the stone's natural crystalline surface.

- Clean the floor with vacuum, broom or dust mop to ensure that all grit is removed.
- Dilute Stone Floor Cleaner according to the instructions on the bottle.
- To clean stone floors and grout, use the Multi-Floor Machine and the tan polish brush (union mix).
- To remove dirt and grime lifted by the brush, mop floors with clean water or with Cleaning Solution.

### Marble Restoration

Marble Restorer polishing cream is a unique blend of microabrasives that safely restores the stone's natural crystalline structure to rejuvenate the shine the marble once had. It will safely and effectively revive dull marble surfaces, light surface scratches, abrasions, etch marks, shower wall streaks, water marks, and glass rings.

#### Equipment and Material Required:

- Multi-Floor Machine
- Black Drive Pad Holder
- Beige Marble Pad
- White Polish Pad
- Stone Floor Cleaner
- Lamb's Wool Bonnet (optional)
- Michaelangelo's Marble Polishing Cream
- Vacuum, Dust Mop or Broom
- Mop & Bucket
- Squeegee

#### Procedure:

1. Clean the floor with vacuum, broom or dust mop to ensure that all grit has been removed. All topical coatings need to be removed.

2. Spray water on the floor and then apply a dab (2 in diameter) per 16 sq ft of surface of Michaelangelo's Marble Restorer® polishing cream.

3. Using Multi-Floor Machine and beige marble pad, begin buffing the area. Buff for five or more passes, keeping the product in a wet slurry. Do not let the product dry on the floor, and spray additional water if necessary.
4. Check results by moving the slurry with a squeegee. Reply or continue to buff if necessary. Remove slurry with squeegee, wet/dry vacuum or clean mop. Immediately mop the floor with a mix of 2 oz of Stone Floor Cleaner and 1 gallon of water, making sure all of the Marble Restorer has been removed from the floor.

5. Let the floor dry completely. Buff the floor with an Multi-Floor Machine and a white polish pad.

floor cleaners. If necessary, repeat procedure until floor shines.

**Sand screening**

**(Wood Floors)**

Sandscreening is ideal for refinishing the polyurethane coating on hard wood floors. The procedure is not designed to totally remove the old polyurethane, but smooth out imperfections and prime the floor for a new fresh coating. However, polyurethane coatings are generally very durable and look good for a long time - try a thorough cleaning before refinishing the polyurethane coating to see if the luster can be restored.

**Equipment and Material Required:**

- Multi-Floor Machine
- Black Drive Pad Holder
- Brown Strip Pad
- Sand Screen 60 grit
- Sand Screen 80 grit
- Sand Screen 100 grit
- Broom or Dust Mop
- Vacuum Cleaner
- Tack Rags

**Procedure:**

1. Use Multi-Floor Machine and the brown strip pad.
2. Place 60 grit sand screen disc under brown strip pad. Sand the floor. Remove residue by vacuuming or sweeping the floor in the same direction as the boards.
3. Place a 80 sand screen disc under the brown strip pad. Sand the floor.
4. Sweep and vacuum the floor, then tack rag THOROUGHLY.
5. Apply finish according to manufacture's recommendations.
6. Burnish between coats with 100 grit sand screen disc and tack rag.

**Surface Cleaning and Waxing Waxed Hard Wood Floors**

**Waxed Hard Wood Floor Applications**

This procedure should be used on WAX FINISH floors only.

**Equipment and Material Required:**

- Multi-Floor Machine
- Black Drive Pad Holder
- Lamb's Wool Bonnet
- Tan Polish Brush (Union Mix)
- White Polish Pad (optional)
- Paste Wax 1 lb.
- Sand paste Wax
- Dust Mop
- Wax

**Procedure:**

1. Completely dust mop floor.
2. Wipe up spills with a dry cloth or paper towel. Use a slightly damp cloth for sticky spills. Hint: Buff with white polish pad to restore luster.
3. To apply paste wax: Attach black drive pad holder to Multi-Floor Machine. Apply a tablespoon of paste wax on 4 sections of white polish pad. Place white polish pad on floor and center black drive and holder onto pad. Work Multi-Floor Machine in a forward/back motion and spread out the paste wax to a thin coat. Allow paste wax to dry for 5 minutes. Turn white polish pad over to clean side and buff. Use tan polish brush or lamb's wool bonnet to obtain a higher luster.

**Helpful Hints:**

1. When floor looks dull, try buffing first to see if that will restore the luster before re-waxing.
2. When areas of heavy use no longer respond to buffing, wax only those areas and buff all of the floor to an even luster.
3. Use clear paste wax to retain the floor's natural color. Use Sand Paste Wax to add a little color and help blend in blemishes on old floors.

**Tile Floor Applications**

**Deep Cleaning**

**Equipment and Material Required:**

- Multi-Floor Machine
- Black Drive Pad Holder
- Orange Scrub Brush or Black Carpet Brush
- White Terrycloth Bonnet
- Tile Floor Cleaner

**Procedure:**

Tile Floor Cleaner lifts dirt, grime and grease from tile floors and grout, leaving sparkling results.

1. Tile Floor Cleaner into a separate spray bottle according to the instructions on the bottle.
2. Lightly spray a 6 ft by 6 ft area with diluted Tile Floor Cleaner.
3. Clean with the Multi-Floor Machine and an orange scrub brush for ceramic tile floors or concrete. Use Multi-Floor Machine and the black carpet brush for delicate or glazed ceramic or porcelain tile floors.
4. Repeat steps 1 through 3 until the whole floor has been cleaned.
5. Go back over the cleaned floor with the Multi-Floor Machine and white terrycloth bonnet to remove all dirt lifted by the orange scrub brush. Wet floor as necessary with water or diluted Tile Floor Cleaner.



CAUTION: FCT recommends removing battery when storing the Multi-Floor Machine. When the machine is not used, it should be stored in the storage position.

**Removing Accessories**

To remove a pad, bonnet, or sand screen:

Lay the Multi-Floor Machine on its back and pull the brush or the black drive pad holder off the beige holder pan.

To remove the battery

1. Put the machine on the floor at the storage / transportation position, turn off the power switch.
2. Grab the battery by the handle with one hand and hold the battery clip by another hand, make sure it is unlocked.
3. Pull the battery out of the slot.



CAUTION: FCT recommends removing battery when storing the Multi-Floor Machine. When the machine is not used, it should be stored in the storage position.

**Turning Floor Machine On and Off**

The on-off switch is located on the handle. It has been designed to be conveniently activated. On (I) - Off (O) is printed on the switch. (See Introduction.) Before turning the machine on, be sure there is a bonnet pad or brush in place on the machine.

**To Guide the Floor Machine**

Turn the power switch on at first. Grasp the unique "T" handle and glide the machine across the floor in a side to side motion. The patented "T" handle feature gives you complete control. The perfectly balanced counter-weight system gives smooth and easy action with fingertip control.

The Indicating lights show the working status of the machine:

Light 1: red, light on when the battery power is low;  
 Light 2: blue, light on when the battery is outputting;  
 Light 3: blue, twinkle for few seconds when the motor is turned on or turned off.

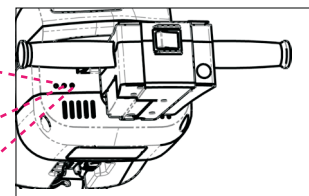

CAUTION: IMPORTANT - Always wear shoes when using your Multi-Floor Machine. Before completing any of the following procedures for the first time, test a small hidden area to ensure color-fastness of the material and that the accessory used is not too aggressive for the surface.

**Carpet and Area Rug Applications**

**Dry Carpet Cleaning**

**For deep cleaning carpet and rugs**

The Fast Dry Carpet Cleaning System® is the easiest and most effective way to keep your carpet and rugs looking clean and beautiful. It effectively removes dirt and grime that vacuums cannot. Unlike many carpet extractors, steam cleaners or steam cleaning services, it will not leave a soapy or sticky residue on your carpet that will attract dirt and cause rapid resoiling. It is safe for use in homes with children and pets.

**Equipment and Material Required:**

- Multi-Floor Machine
- Black Drive Pad Holder
- White Terrycloth Bonnet (for berber or low-pile carpets) or Black Carpet Brush (for medium- or high-pile carpets)
- Fast Premist® Soil Release Pre-Spray
- Fast Dry Carpet Cleaner

**Procedure:**

1. Spray Premist® Soil Release Pre-Spray on the carpet in a 6 ft by 6 ft area.
2. Sprinkle Dry Carpet Cleaner over the treated area (do not over use).
3. Work the Dry Carpet Cleaner into the carpet with the Multi-Floor Machine and the white terrycloth bonnet (for berber or low-pile carpets) or black carpet brush (for medium- or high-pile carpets).
4. Repeat steps 1 through 3 until the whole carpet has been treated. The carpet can be walked on during or immediately after the treatment with no ill effects.
5. When the white terrycloth bonnet becomes soiled, turn it over. When the job is complete, clean the white terrycloth bonnet in the washing machine using cold water or hose off and allow to air dry.
6. After waiting at least 30 minutes, vacuum the treated areas with an Fast vacuum cleaner.

See Dry Carpet Cleaner packaging for complete instructions.

**Bonnet Cleaning**

**(For surface cleaning carpet and rugs)**

This procedure can be used on most types of carpets (follow manufacturer's recommendations for handmade, silk and oriental rugs or carpets).

**Equipment and Material Required:**

- Multi-Floor Machine
- Black Drive Pad Holder
- White Terrycloth Bonnet
- Fast Premist® Soil Release Pre-Spray

**Procedure:**

1. Lightly spray Premist® Soil Release Pre-Spray over the soiled area in the carpet or high traffic area.
2. Use the Multi-Floor Machine and the white terrycloth bonnet to lift dirt from the treated area. Work terrycloth bonnet over the treated area.
3. Turn terrycloth bonnet over when soiled and continue to clean carpet.
4. When the job is complete, clean the white terrycloth bonnet in the washing machine using cold water or hose off and allow to air dry.

## Laminated, Vinyl and Linoleum Floor Applications

**Surface Cleaning**

Timberworks® Floor Cleaner restores the natural beauty of all your hard flooring (**not for use on stone, tile, or waxed floors**). It safely and effectively removes the dirt, scuffs and grime from your floors to reveal their original and beautiful luster.

**Equipment and Material Required:**

- Multi-Floor Machine
- Black Drive Pad Holder
- White Terrycloth Bonnet
- Timberworks® Floor Cleaner
- White Polish Pad (optional)

**Precautions:**

To clean hard flooring, including polyurethane-coated wood, laminate, vinyl and linoleum floors, use the Timberworks® Floor Cleaner and the Multi-Floor Machine with the white terrycloth bonnet.

1. Lightly mist a 6 ft by 6 ft area. Floor Cleaner (a little goes a long way).
2. Clean the treated area with the Multi-Floor Machine and the white terrycloth bonnet.
3. Floors should shine with a beautiful luster. Floor Cleaner will not leave a residue; any streaking or clouding may be the result of a build-up or other floor cleaners. If necessary, repeat procedure until floor shines.
4. If desired, vinyl and laminate flooring can be polished to a higher luster using the white polish pad after Multi-Floor Machine cleaning.

**EXCEPT WOOD FLOORS. This procedure can be used on hard floor surfaces.****Scrubbing**

- Multi-Floor Machine
- Black Drive Pad Holder
- Brown Strip Pad or Blue Scrub Pad depending on floor surface
- Orange Scrub Brush
- Vacuum, Broom or Dust Mop

## E N G L I S H

- Cleaning Solution
- Interior Circle (Donut Hole) from Brown Strip Pad or Blue Scrub Pad
- Mops - 2 (1 to apply/pick up Cleaning Solution and 1 to rinse floor)
- Wet-Dry Vacuum (optional)
- Bucket and wringer

**Procedure:**

1. Vacuum or sweep floor area to be cleaned with broom or dust mop.
2. Mix cleaning solution according to manufacturer's instructions on container label.
3. Apply cleaning solution in a 6 ft by 6 ft area.
4. Let solution stand for 5 minutes, scrub floor with Multi-Floor Machine and brown strip pad or blue scrub pad.
5. Use orange scrub brush on floors with cracks, crevices, and grout.
6. Use interior circle (donut hole) from the brown strip pad or blue scrub pad to clean in corners and around door jambs by hand.
7. Pick up dirty solution with mop or wet-dry vacuum.

**DO NOT ALLOW CLEANING SOLUTION TO DRY ON FLOOR.**

8. Repeat Steps 3-6 until all floor area is cleaned.
9. Mop or use Multi-Floor Machine with the white terrycloth bonnet and clean water to rinse the floor area.

**Precautions:**

1. Do not flood the floor area with cleaning solution or allow solution to dry before pick-up.
2. Use clean mop for final rinse.
3. Change rinse water frequently.
4. Use damp cloth to wipe off any splashes on walls or furniture.

**Stripping**

This procedure can be used on most types of hard floor surfaces. **EXCEPT WOOD & STONE FLOORS**, to remove buffable floor wax or coatings.

**Equipment and Material Required:**

- Multi-Floor Machine
- Black Drive Pad Holder
- Brown Strip Pad
- Vacuum, Broom or Dust Mop
- Wax Remover or Stripping Solution
- Interior Circle (Donut Hole) from Brown Strip Pad
- Mops - 2 (1 to apply/pick up Cleaning Solution and 1 to rinse floor)
- Bucket and Wringer
- Wet-Dry Vacuum for dirty and rinse water pick-up (optional)

**Procedure:**

1. Vacuum or sweep floor area to be stripped with broom or dust mop.
2. Mix stripping solution according to manufacturer's instructions on container label.

## E N G L I S H

3. Dip mop in stripping solution and apply to floor in a 6 ft by 6 ft area. Apply along baseboard edges first or where there is a wax or dirt build-up.
4. Let solution stand for 5 minutes, scrub floor with Multi-Floor Machine and the brown strip pad. Use interior circle (donut hole) from the brown strip pad to reach in corners and around door jambs.
5. To pick up dirty solution, use a mop or wet-dry vacuum. **DO NOT ALLOW STRIPPING SOLUTION TO DRY ON FLOOR.**
6. Repeat steps 3-5 until the entire floor is completely stripped.
7. Pick up area TWICE with clean water and clean mop.
8. Allow floor to dry before applying new floor finish.

**Precautions:**

1. Do not flood the floor with stripping solution or allow solution to dry before pick-up.
2. Use clean mop for final rinse.
3. Change rinse water frequently.
4. Use damp cloth to wipe off any splashes on walls or furniture.

**Precautions:**

8. Allow 24 hours for floor finish to harden before buffing.
9. Buff floor to higher shine using Multi-Floor Machine and white polish pad or lamb's wool bonnet.

1. When using NEW mops to apply floor finish, make sure to rinse mop first. Foreign chemicals will affect the floor finish.
2. Completely submerging mop head into the floor finish is a waste of product.
3. Turn mop over frequently for even distribution of floor finish.
4. Do not allow mop to become dry; this will cause streaking.
5. Apply floor finish in thin even coats.
6. Do NOT pour floor finish directly on the floor and attempt to spread evenly. This will cause dark spots and delay drying time.

## Sealed Hard Wood Floor Applications

This procedure is for polyurethane-sealed hard wood floors, not waxed hard wood floors.

Floor Cleaner restores the natural beauty of all your hard flooring (not for use on stone, tile, or waxed floors). It safely and effectively removes the dirt, scuffs and grime from your floors to reveal their original and beautiful luster.

**Equipment and Material Required:**

- Orbiter® Multi-Floor Machine
- Black Drive Pad Holder
- White Terrycloth Bonnet
- White Polish Pad (optional)

**Procedure:**

To clean hard flooring, including polyurethane-coated wood, laminate, vinyl and linoleum floors, use the Floor Cleaner and the Multi-Floor Machine with the white terrycloth bonnet. Vinyl and laminate flooring can be polished to a higher luster using the white polish pad after cleaning.

1. Lightly mist a 6 ft by 6 ft area with Floor Cleaner (a little goes a long way).
2. Clean the treated area with the Multi-Floor Machine and the white terrycloth bonnet.
3. Floors should shine with a beautiful luster. Floor Cleaner will not leave a residue; any streaking or clouding may be the result of a build-up or other

4. Apply floor finish in thin even coats. Apply FIRST COAT of floor finish along baseboard edges and cover remaining floor area in an left-right direction. **HINT:** Only the first coat of floor finish needs to be applied to baseboard edges.
5. Allow floor finish to dry for 20 minutes before applying a second coat.
6. Apply the second coat of floor finish 1 tile width from baseboard. Application should be in a crossing direction to the preceding coat.