

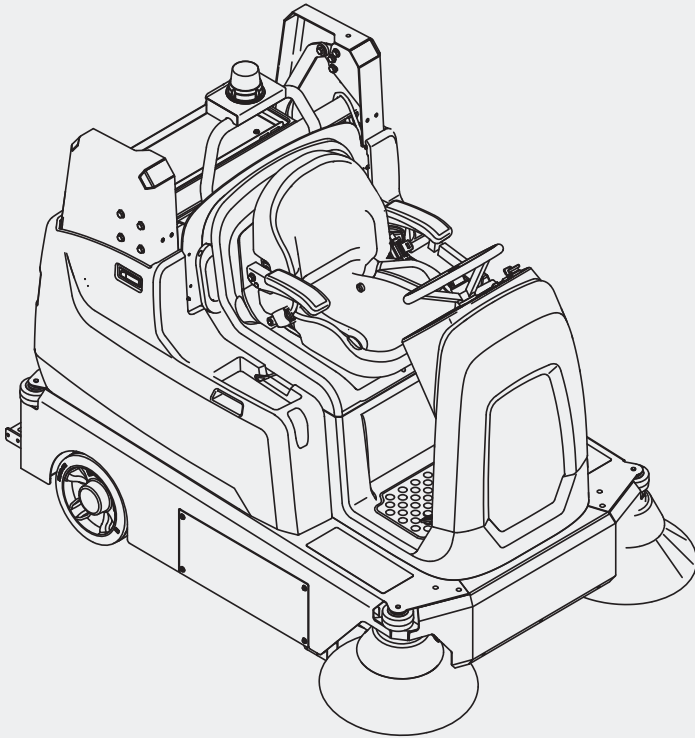

S16

(Battery)

Sweeper Operator Manual



Tennant True® Parts
IRIS® a Tennant Technology



North America / International



For the latest Parts Manuals and other
language Operator Manuals, visit:

www.tennantco.com/manuals

9045321
Rev. 00 (09-2020)



INTRODUCTION

This manual is furnished with each new model. It provides necessary operation and maintenance instructions.



Read this manual completely and understand the machine before operating or servicing it.

This machine will provide excellent service. However, the best results will be obtained at minimum costs if:

- The machine is operated with reasonable care.
- The machine is maintained regularly - per the machine maintenance instructions provided.
- The machine is maintained with manufacturer supplied or equivalent parts.

	<p>PROTECT THE ENVIRONMENT</p> <p>Please dispose of packaging materials, used components such as batteries and fluids in an environmentally safe way according to local waste disposal regulations.</p> <p>Always remember to recycle.</p>	<p>MACHINE DATA</p> <p>Please fill out at time of installation for future reference.</p> <p>Model No. - _____</p> <p>Serial No. - _____</p> <p>Installation Date - _____</p>	
--	---------------------------------------------------------------------------------------------------------------------------------------------------------------------------------------------------------------------------------------------------	-------------------------------------------------------------------------------------------------------------------------------------------------------------------------------------	--

INTENDED USE

The S16 is an industrial rider machine designed to sweep both rough and smooth hard surfaces (concrete, tile, stone, synthetic, etc) and carpeted surfaces (commercial grade nylon, polyester, and / or wool). Typical applications include schools, office buildings, convention centers, airports, warehouses, manufacturing facilities, and retail centers. Do not use this machine on soil, grass, or surfaces with residential type carpeting. This machine is intended for both indoor and outdoor use. This machine is not intended for use on public roadways. Do not use this machine other than described in this Operators Manual.

Tennant Company

10400 Clean Street
Eden Prairie, MN 55344-2650
Phone: (800) 553-8033
www.tennantco.com

MaxPro²™, VarioHeight™, Eco-Mode™, Smart-Fill™, 1-Step™, Thermo-Sentry™, Perma-Filter™, Duramer™, and FiberShield™ are trademarks of Tennant Company.

Specifications and parts are subject to change without notice.

Original Instructions, copyright© 2020 TENNANT Company, Printed in U.S.A.

CONTENTS

Contents	3	Emptying The Hopper	29
Important Safety Instructions - Save These Instructions	6	Emptying The Hopper (High Dump Machines).....	29
Operation.....	12	Emptying The Hopper (Low Dump Machines).....	31
Machine Components	12	Engaging The Hopper Support Bar (High Dump Machines).....	33
Control Panels	13	Disengaging The Hopper Support Bar (High Dump Machines).....	33
Control Pedals	14	Turning Off The Machine.....	34
Symbol Definition	15	Cleaning The Machine	34
Installing Batteries.....	16	Fault / Alert Codes And Indicators.....	35
Flooded/Sealed Lead-Acid Batteries.....	16	Faults / Alerts Indicator Codes	35
Operation Of Controls	17	Machine Service Indicator Codes	36
Battery Discharge Indicator.....	17	On-Board Battery Charger Service Indicator Codes	37
Worn Brush Indicator	17	Lithium-Ion Battery System Service Indicator Codes	38
Smart-Fill ABW (Automatic Battery Watering Indicator) (Option)	17	Options.....	39
HEPA (High Efficiency Particulate Arrestance) Indicator (Machines Equipped With Hepa Filtration System Option Only)	18	Vacuum Wand (Option).....	39
Fault Indicator	18	Blue Pedestrian Lights (Option)	39
Hour Meter	18	Adjusting Backup Alarm Volume (Option)	40
1-Step Button	18	Machine Troubleshooting.....	41
Hopper Safety Button.....	19	HEPA Filter System Troubleshooting	42
Vacuum Fan Button.....	19	Maintenance.....	43
Left And Right Side Brush Buttons.....	19	Maintenance Chart.....	44
Eco (Economy) Mode Button	20	Yellow Touch Points	47
Filter Shaker Button	20	Lubrication	47
Emergency Shut-Off Button	21	Steering Chain	47
Directional Switch.....	21	Hopper Lift Arm Pivots (High Dump Machines).....	47
Operating / Hazard Light Switch (Option)	21	Hydraulics (High Dump Machines)	48
Propel Pedal.....	22	Hydraulic Fluid	48
Brake Pedal.....	22	Hydraulic Hoses	48
Large Debris Flap Trap Pedal	22	Batteries.....	49
Operator Seat.....	22	Flooded (Wet) And Maintenance-Free Sealed Lead-Acid Batteries	49
Seat Belts (Deluxe Seat Option Only).....	22	Checking The Electrolyte Level.....	49
Seat Support	23	Maintenance-Free Batteries.....	50
How The Machine Works	24	Checking Connections / Cleaning	50
Brush Information.....	24	Lithium-Ion Battery Pack.....	50
While Operating The Machine.....	25	Charging The Batteries	51
Pre-Operation Checklist.....	25	On-Board And Off-Board Battery Charger Settings	52
Turning On The Machine	26	Opportunity Charging (Lithium-Ion Batteries Only).....	53
Brush Pressure	26		
Setting The Main Brush Pressure	26		
Sweeping	27		
Stop Sweeping.....	28		

CONTENTS

Manual Battery Watering System.....	54	Sweep Compartment HEPA Side Skirts (Machines Equipped With HEPA Filtration System Option Only)	74
Smart-Fill ABW (Automatic Battery Watering) System.....	55	Brush Compartment Skirts (Machines Equipped With HEPA Filtration System Option Only)	74
Battery Compartment Drain Valve.....	56	Main Brush Door Seals (Machines Equipped With HEPA Filtration System Option Only)	75
Circuit Breakers, Fuses, And Relays	57	Belts	75
Circuit Breakers	57	Main Brush Drive Belt	75
Fuses	58	Tires	75
Relays	58	Vacuum Wand Maintenance (Option)	75
Electric Motors	58	Vacuum Wand Fan.....	75
HEPA (High Efficiency Particulate Arrestance) Filtration System (Option) ..	59	Replacing The Vacuum Wand Bag	76
Hopper	59	Pushing, Towing, And Transporting The Machine	77
Cleaning The Low Dump Hopper.....	59	Pushing Or Towing The Machine	77
Cleaning The High Dump Hopper	59	Transporting The Machine	77
Hopper Dust Filter.....	60	Machine Jacking	79
Removing / Replacing The Hopper Dust Filter	60	Storage Information	80
Cleaning The Hopper Dust Filter (Machines Equipped With Standard Filtration System).....	61	Specifications	82
Cleaning The Hopper Dust Filter (Machines Equipped With HEPA Filtration System Only).....	61	General Machine Dimensions/Capacities	82
Adjusting The Hopper Filter Cover Latches.....	62	General Machine Performance	83
Inspecting / Cleaning The Perma-Filter....	62	Power Type	83
Thermo-Sentry	62	Tires	83
Replacing The HEPA Filter.....	63	Machine Dimensions - Low Dump	84
Main Sweep Brush.....	65	Machine Dimensions - High Dump	85
Replacing The Main Sweeping Brush	65	Supervisor Controls	87
Checking The Main Sweep Brush Pattern.....	67	Entering The Supervisor Mode	87
Adjusting The Main Sweep Brush Pattern.....	68	Changing The Machine Speed	88
Side Brush(es)	69	Index.....	89
Replacing The Side Brush(es)	69		
Checking The Side Brush Pattern(s).....	70		
Adjusting The Side Brush Pattern(s).....	71		
Skirts And Seals.....	72		
Large Debris Trap Skirt	72		
Side Skirts	72		
Side Recirculation Skirts	73		
Rear Skirt	73		
Rear Recirculation Skirt	73		
Side Brush Dust Control Skirts (Option)...	73		
Hopper Seals	74		
Vacuum Seal	74		

**IMPORTANT SAFETY INSTRUCTIONS
- SAVE THESE INSTRUCTIONS**

The following precautions are used throughout this manual as indicated in their descriptions:



WARNING: To warn of hazards or unsafe practices that could result in severe personal injury or death.



CAUTION: To warn of unsafe practices that could result in minor or moderate personal injury.

FOR SAFETY: To identify actions that must be followed for safe operation of equipment.

The following information signals potentially dangerous conditions to the operator. Know when these conditions can exist. Locate all safety devices on the machine. Report machine damage or faulty operation immediately.



WARNING: Lead-acid batteries emit hydrogen gas. Explosion or fire can result. Keep sparks and open flame away. Keep covers open when charging.



WARNING: Flammable materials or reactive metals can cause an explosion or fire. Do not pick up.



WARNING: Raised hopper may fall. Engage hopper support bar.



WARNING: Lift arm pinch point. Stay clear of hopper lift arms.



WARNING: Heavy object. Back injury could result from improper lifting. Use hoist when removing.



WARNING: Electrical Hazard
– Disconnect Battery Cables and Charger Plug Before Servicing Machine.

– Do Not Charge Batteries with Damaged Power Supply Cord. Do Not Modify Plug.

If the charger supply cord is damaged or broken, it must be replaced by the manufacturer or its service agent or a similarly qualified person in order to avoid a hazard.

This machine may be equipped with technology that automatically communicates over the cellular network. If this machine will be operated where cell phone use is restricted because of concerns related to equipment interference, please contact a Tennant representative for information on how to disable the cellular communication functionality.

FOR SAFETY:

1. Do not operate machine:
 - Unless trained and authorized.
 - Unless operator manual is read and understood.
 - Under the influence of alcohol or drugs.
 - While using a cell phone or other types of electronic devices.
 - Unless mentally and physically capable of following machine instructions.
 - With brake disabled.
 - Without filters in place or with clogged filters.
 - In dusty environments without the vacuum fan on.
 - If it is not in proper operating condition.
 - In areas where flammable vapors/liquids or combustible dusts are present.
 - In areas that are too dark to safely see the controls or operate the machine unless operating / headlights are turned on.
 - In areas with possible falling objects unless equipped with overhead guard.
2. Before Starting Machine:
 - Check machine for fluid leaks.
 - Make sure all safety devices are in place and operate properly.
 - Check brakes and steering for proper operation.
 - Adjust seat and fasten seat belt (if equipped).

3. When using machine:
 - Use only as described in this manual.
 - Use brakes to stop machine.
 - Do not pick up burning or smoking debris, such as cigarettes, matches or hot ashes.
 - Go slowly on inclines and slippery surfaces.
 - Do not sweep on ramp inclines that exceed 14.1% / 8° grade. Do not transport on ramp inclines that exceed 21.3% / 12° grade.
 - Reduce speed when turning.
 - Keep all parts of body inside operator station while machine is moving.
 - Always be aware of surroundings while operating machine.
 - Use care when reversing machine.
 - Move machine with care when hopper is raised (High Dump).
 - Make sure adequate clearance is available before raising hopper (High Dump).
 - Do not raise hopper when machine is on an incline (High Dump).
 - Use care when emptying hopper. Hopper can hold up to 91 kg (200 lbs). Lifting heavy material improperly can result in back strain or other personal injury (Low Dump).
 - Keep children and unauthorized persons away from machine.
 - Do not carry passengers on any part of the machine.
 - Always follow safety and traffic rules.
 - Report machine damage or faulty operation immediately.
 4. Before leaving or servicing machine:
 - Stop on level surface.
 - Turn off machine and remove key.
 5. When servicing machine:
 - All work must be done with sufficient lighting and visibility.
 - Keep work area well ventilated.
 - Avoid moving parts. Do not wear loose clothing, jewelry and secure long hair.
 - Block machine tires before jacking machine up.
 - Jack machine up at designated locations only. Support machine with jack stands.
 - Use hoist or jack that will support the weight of the machine.
 - Do not push or tow the machine without an operator in the seat controlling the machine.
 - Do not push or tow the machine on inclines with the brake disabled.
 - Use cardboard to locate leaking hydraulic fluid under pressure.
- Do not power spray or hose off machine near electrical components.
 - Disconnect battery connections and charger cord before working on machine.
 - Do not pull on battery charger cord to unplug. Grasp plug at outlet and pull.
 - Do not use incompatible battery chargers as this may damage battery packs and potentially cause a fire.
 - Inspect charger cord regularly for damage.
 - Do not disconnect the off-board charger's DC cord from the machine receptacle when the charger is operating. Arcing may result. If the charger must be interrupted during charging, disconnect the AC power supply cord first.
 - Avoid contact with battery acid.
 - Keep all metal objects off batteries.
 - Use a non-conductive battery removal device.
 - Use a hoist and adequate assistance when lifting batteries.
 - Battery installation must be done by trained personnel.
 - Follow site safety guidelines concerning battery removal.
 - All repairs must be performed by a trained service mechanic.
 - Do not modify the machine from its original design.
 - Use Tennant supplied or approved replacement parts.
 - Wear personal protective equipment as needed and where recommended in this manual.



For Safety: wear hearing protection.



For Safety: wear protective gloves.



For Safety: wear eye protection.



For Safety: wear protective dust mask.

6. When loading/unloading machine onto/off truck or trailer:
 - Use ramp, truck or trailer that will support the weight of the machine and operator.
 - Empty debris hopper before loading machine.
 - Do not drive on slippery ramp.
 - Use caution when driving on a ramp.
 - Do not load/unload machines on ramp inclines that exceed 21.3% / 12°.
 - Turn off machine and remove key.
 - Block machine tires.
 - Tie machine down to truck or trailer.

7. When using Lithium-ion Battery Model:
 - Battery service to be performed by Tennant Service only.
 - Do not attempt to lift battery by hand or by any other unauthorized method.
 - Battery pack is designed exclusively for specific Tennant machine applications. Do not install battery pack in unapproved machines.
 - Dispose of battery in accordance with local regulations. Contact Tennant Service.
 - Contact Tennant Service or your local regulatory authorities for proper transporting instructions of lithium-ion batteries.
 - Disconnect battery cable connector, battery management system (BMS) connector and charger cord before working on machine.
 - Use only OEM approved battery charger supplied with lithium-ion battery.
 - Do not expose battery to temperatures below -22°F (-30°C), above 140°F (60°C).
 - Do not use machine immediately after long-term extreme temperature storage. Before use, return battery module temperature range to 50°F (10°C)~95°F (35°C).
 - Do not operate or store battery in hazardous environment (electrically charged, humidity, extreme temperatures and magnetic fields).
 - Do not expose battery to flame or plasma.
 - Do not disassemble or mistreat battery. Do not tear seal tape or will void warranty.
 - Do not drop, crush or subject battery to impact, as it may cause battery to heat up or catch fire.
 - Do not put battery in fire or water to avoid battery explosion.
 - Do not touch battery with wet hand, avoid electric shock.
 - Stop using or charging the battery immediately if battery has abnormal temperature, leakage or other abnormal conditions.

The following safety labels are mounted on the machine in the locations indicated. Replace damaged/missing labels

WARNING LABEL -
Lift pinch point. Stay clear of hopper lift arms.

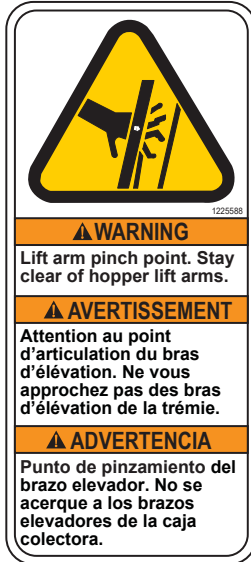

Located on back of both lift arms (high dump machines only).

FOR SAFETY LABEL - Authorized Service Mechanic Only.

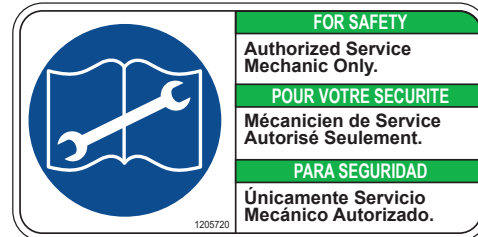

Located on electronic compartment cover (behind operator seat shroud).

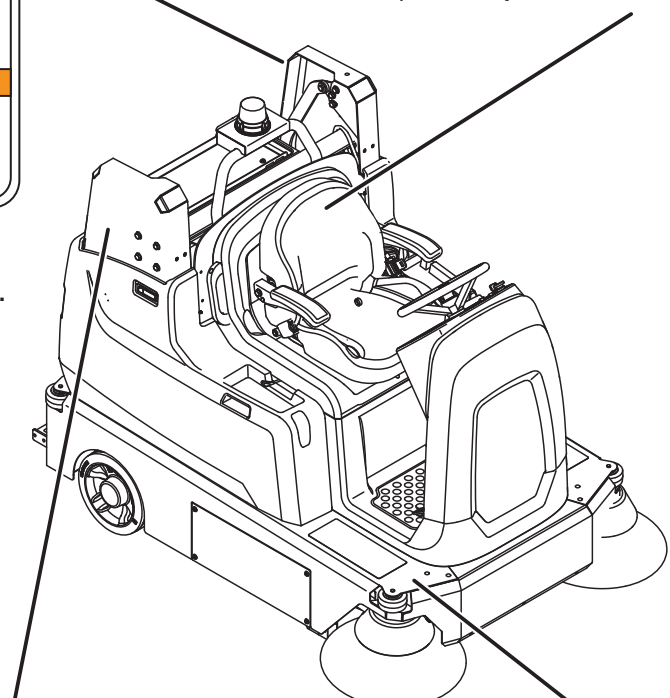

WARNING LABEL - Raised hopper may fall.
Engage hopper support bar.

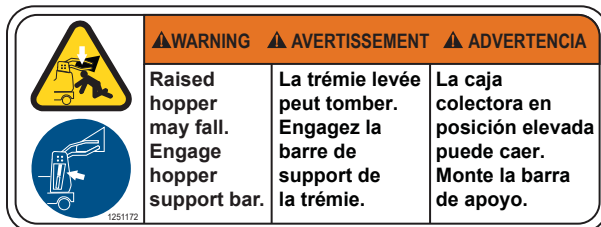

Located on side of both lift arms (high dump machines only).

WARNING LABEL - Spinning brush.
Keep hands away.



Located on side brush plate(s) (machines equipped with optional side brush(es) only).

SAFETY

WARNING LABEL -
Batteries emit hydrogen gas. Explosion or fire can result. Keep sparks and flames away. Keep covers open when charging.



Located on bottom of seat shroud plate.

FOR SAFETY LABEL - Authorized Service Mechanic Only.

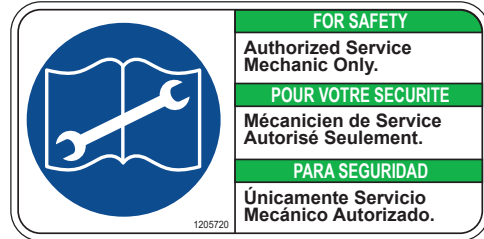

Located on electrical panel.

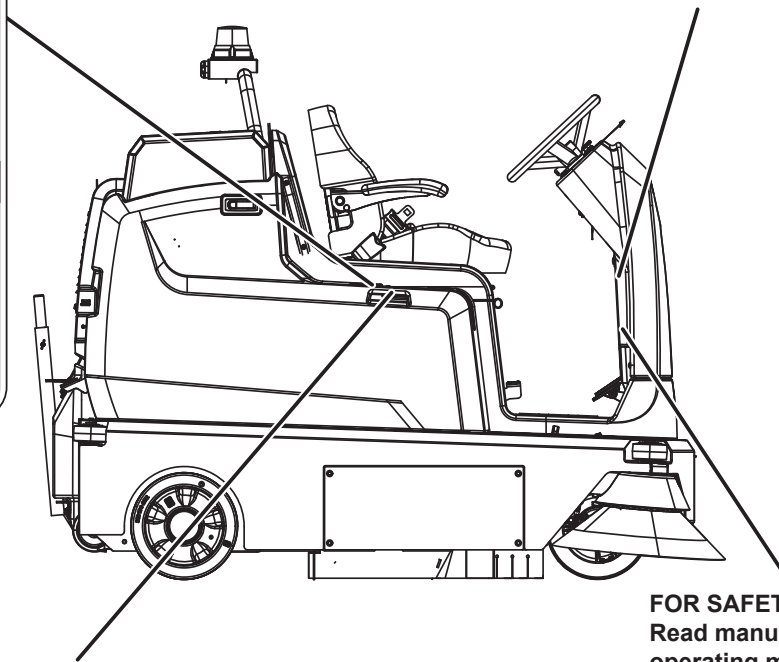

FOR SAFETY LABEL -
Read manual before operating machine.

WARNING LABEL - Electrical hazard. Do not charge batteries with damaged cord.

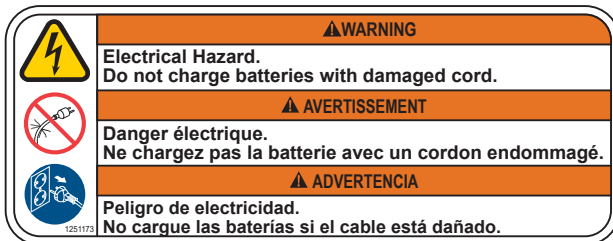

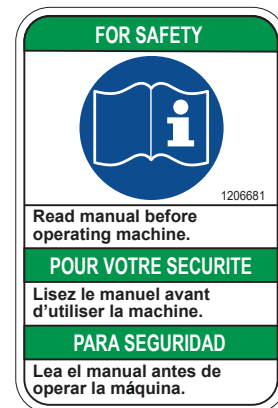

Located on bottom of seat shroud plate.



Located on electrical panel.



LITHIUM-ION BATTERY CAUTION LABEL

⚠ CAUTION	⚠ ATTENTION	⚠ ATENCIÓN
<ol style="list-style-type: none"> 1. Do not expose battery to temperatures below -30° C (-22°F), above 60°C (140°F). 2. Do not disassemble or mistreat battery. Do not crush. 3. Do not drop or subject it to impact. 4. Use only OEM approved charger. 5. Failure to follow these instructions may present risk of explosion, fire, or high temperatures. 6. See owner's manual for additional safety instructions. 7. Recommended torque for stud assembly is; M8 = 9.1Nm / M12 = 24.5Nm. 8. Refer to owner's manual for lifting instructions. 9. Service by Tennant Personnel only. 	<ol style="list-style-type: none"> 1. No exponga la batería a temperaturas por debajo de -30 ° C (-22°F), por encima de 60 ° C (140 ° F). 2. No desarmar ni maltratar la batería. No la aplaste. 3. No deje caer ni la someta a impactos. 4. Use sólo el cargador Original aprobado. 5. El incumplimiento de estas instrucciones puede presentar riesgo de explosión, fuego o altas temperaturas. 6. Véase el manual del propietario para instrucciones adicionales de seguridad. 7. El par recomendado de apriete para el poste es de; M8 - 9.1Nm / M12 = 24.5Nm. 8. Consulte el manual del propietario para las instrucciones de elevación. 9. Servicio por técnicos de Tennant exclusivamente. 	<ol style="list-style-type: none"> 1. N'exposez pas la batterie à des températures inférieures à -30 ° C (supérieures à 60 ° C). 2. Ne pas démonter ni maltraiter la batterie. Ne pas écraser. 3. Ne la laissez pas tomber et ne la soumettez pas à un impact. 4. Utilisez uniquement un chargeur approuvé par l'OEM. 5. Le non-respect de ces instructions peut présenter un risque d'explosion, d'incendie ou de températures élevées. 6. Voir le manuel du propriétaire pour les consignes de sécurité supplémentaires. 7. Le couple recommandé pour le montage des goujons est de; M8 - 9.1Nm / M12 = 24.5 Nm. 8. Reportez-vous au manuel du propriétaire pour les instructions de levage. 9. Service réservé au personnel Tennant.
	<p>Tennant Co File Number: MH63465</p> 	<p>Battery Disposal contact Tennant Technical Service 1-800-553-8033</p> <p style="text-align: right;">1247721</p>

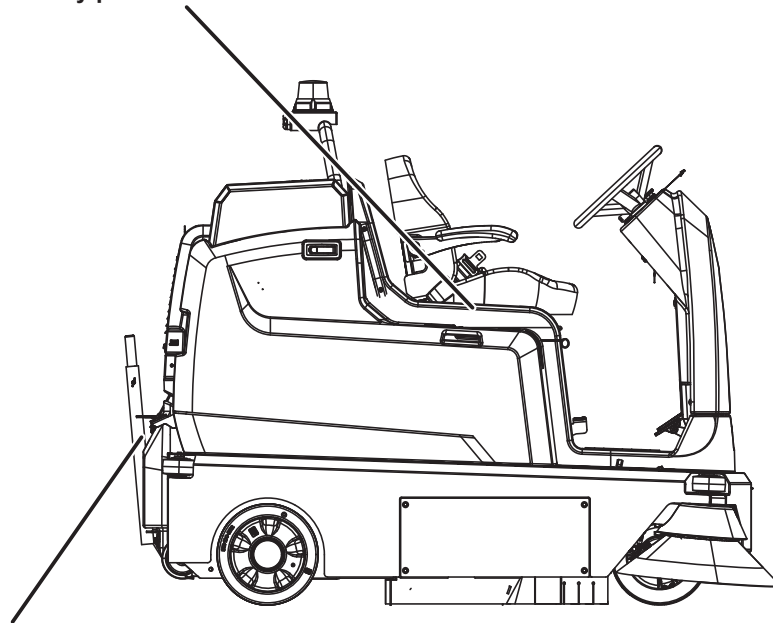
Located on top of battery pack.



WARNING LABEL - Brush throws debris. Stop motor before lifting hopper.

⚠ WARNING	⚠ AVERTISSEMENT	⚠ ADVERTENCIA
 	<p>Brush throws debris. Stop motor before lifting hopper.</p>	<p>La brosse projette des débris. Coupez le moteur avant de relever la trémie.</p>
		<p>Depósito de desperdicios del cepillo. Detenga el motor antes de elevar la caja colectora.</p>

Located on back of hopper (low dump machines only)

OPERATION

MACHINE COMPONENTS

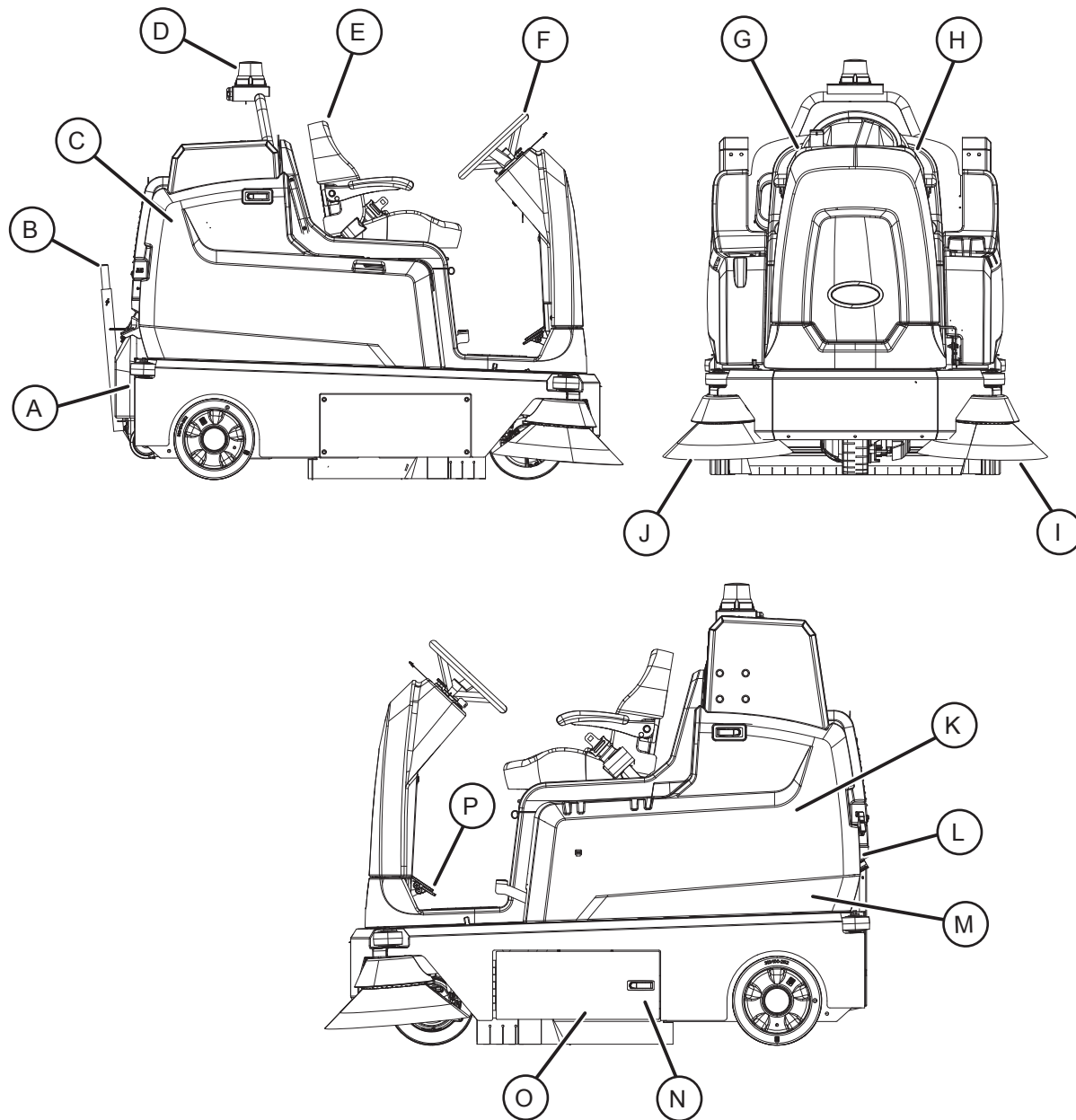

- A. Hopper
- B. Hopper handle (Low Dump Only)
- C. Right shroud
- D. Backup alarm / flashing light (Option)
- E. Operator seat
- F. Steering wheel
- G. Right control panel
- H. Left control panel
- I. Left side brush (Option)
- J. Right side brush (Option)
- K. Hopper support (High Dump Only)
- L. Hopper filter
- M. Left shroud
- N. Main sweep brush access door
- O. Main sweep brush
- P. Control pedals

CONTROL PANELS

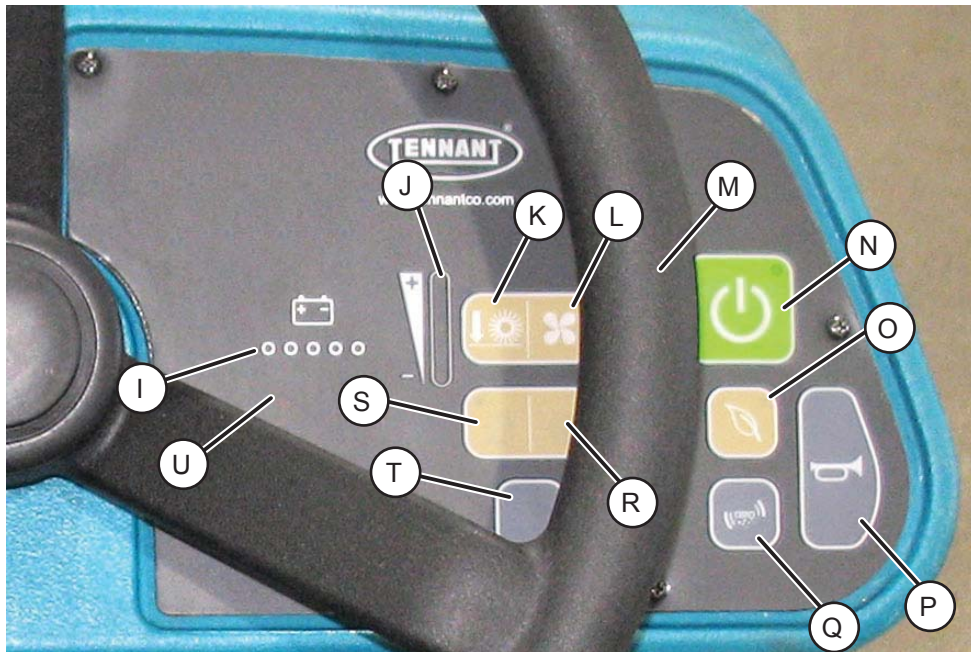
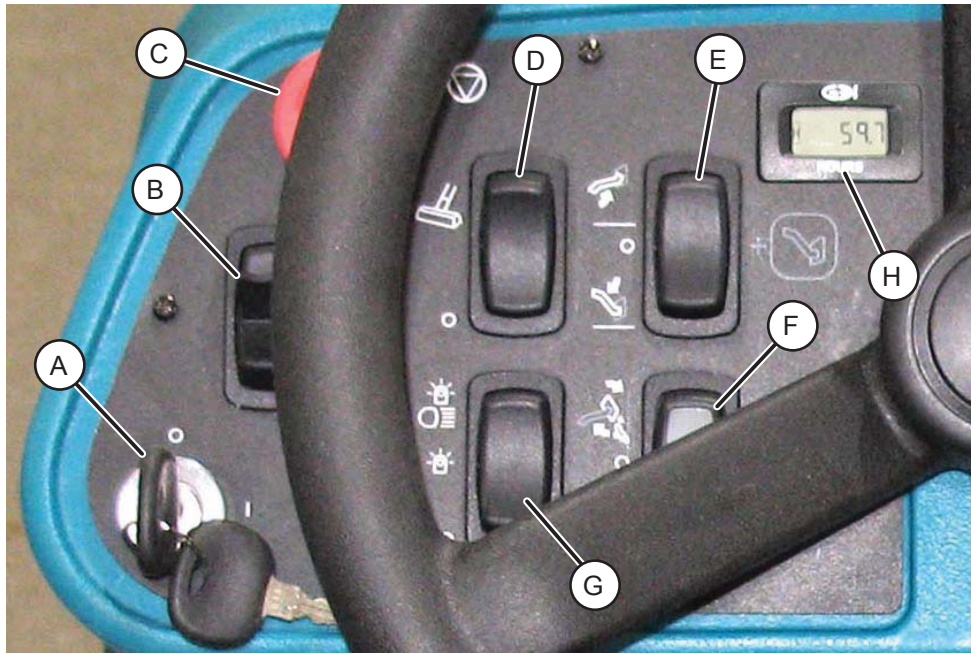

- | | |
|-----------------------------------------------------|------------------------------------------------------------------------------------------------------------------------------------------------------|
| A. Key switch | L. Vacuum fan button |
| B. Directional switch | M. Vacuum fan indicator lights (behind steering wheel) |
| C. Emergency shut-off button | N. 1-Step button |
| D. Vacuum wand switch (Option) | O. ECO (Economy) button |
| E. Hopper raise / lower switch (High Dump Only) | P. Horn button |
| F. Hopper rollout switch (High Dump Only) | Q. Filter shaker button |
| G. Operating lights / hazard lights switch (Option) | R. Right side sweep brush button |
| H. Hour meter | S. Left side sweep brush button (Option) |
| I. Battery indicator lights | T. Hopper safety button (High Dump Only) |
| J. Main brush pressure indicator rights | U. Indicators lights (Worn brush, Smart-Fill ABW (Automatic Battery Watering) tank low (Option), HEPA filter clogged (Option), and Fault indicators) |
| K. Main brush pressure button | |



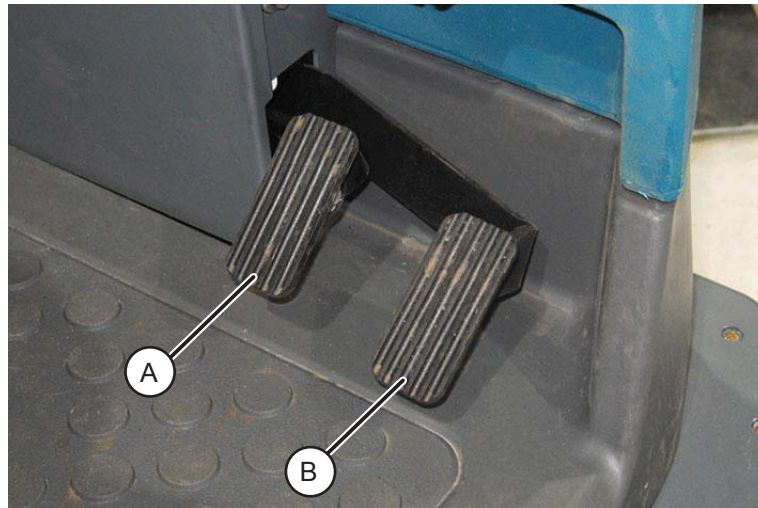





















CONTROL PEDALS



- A. Brake pedal
- B. Propel pedal
- C. Large debris trap pedal

SYMBOL DEFINITION

These symbols are used on the machine to identify controls, displays, and features.

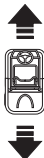
	On		Off
	Fault/Alert indicator		Horn
	Worn main brush		Smart-Fill ABW (Automatic Battery Watering) (option)
HEPA	HEPA (High Efficiency Particulate Arrestance)		Eco (Economy Mode)
	<i>1-Step</i>		Emergency shut-off
	Operating lights / Hazard light		Filter shaker
	Left side brush (option)		Hazard light
	Right side brush		Circuit breaker
	Vacuum fan		Jack point
	Raise hopper		Battery charge
	Lower hopper		Vacuum wand (option)
	Roll hopper roll out		Hopper safety
	Roll hopper roll in		Forward / Reverse

OPERATION

INSTALLING BATTERIES

FLOODED/SEALED LEAD-ACID BATTERIES



WARNING: Fire Or Explosion Hazard. Batteries Emit Hydrogen Gas. Keep Sparks And Open Flame Away. Keep Battery Hood Open When Charging.

FOR SAFETY: When servicing machine: Keep all metal objects off batteries. Use a non-conductive battery removal device. Use a hoist and adequate assistance when lifting batteries. Battery installation must be done by trained personnel. Follow site safety guidelines concerning battery removal.

BATTERY SPECIFICATIONS

Six 6-volt deep cycle lead acid batteries.

Maximum battery dimensions: 28.8 in / 731 mm W x 19.9 in / 506 mm L x 15.6 in / 395 mm H.

1. Park the machine on a level surface and remove the key.
2. Lift the battery compartment cover open and engage the support.

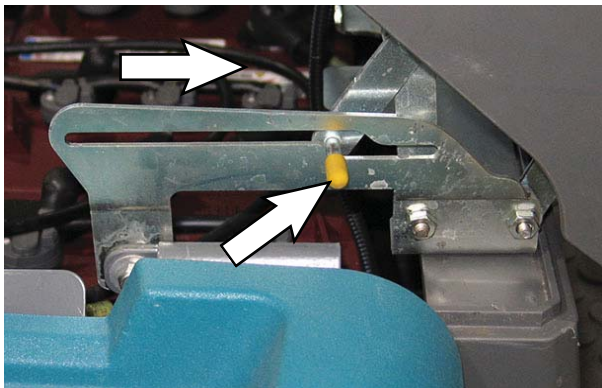
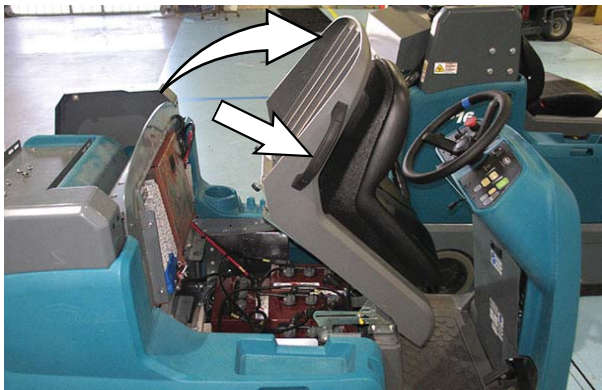

3. Remove the bracket from the rear of the battery compartment.

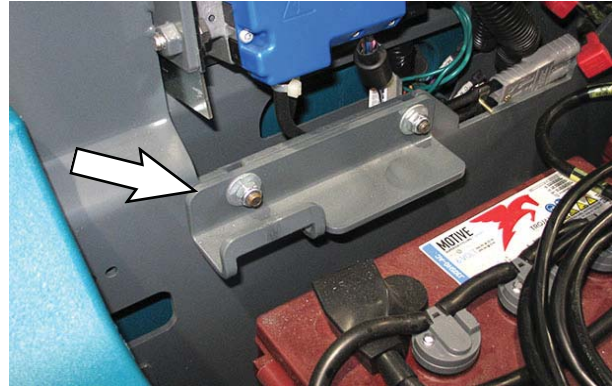

4. With adequate assistance carefully install the batteries into the battery compartment tray and arrange the battery posts as shown. Insert the foam spacers along side the batteries as shown if installing the smaller batteries.

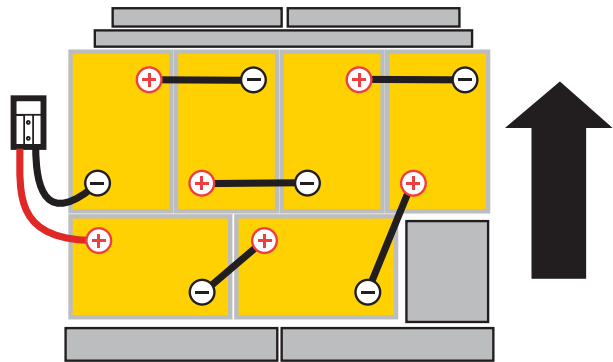

5. Using the supplied battery post boots, connect the cables to the battery posts, RED TO POSITIVE (+) & BLACK TO NEGATIVE (-).

IMPORTANT: Before charging, make sure that the charger setting is properly set for the battery type.

6. Reinstall the bracket onto the rear of the battery compartment.

OPERATION OF CONTROLS

BATTERY DISCHARGE INDICATOR

The *battery discharge indicator* displays the charge level of the batteries while the machine is operating.

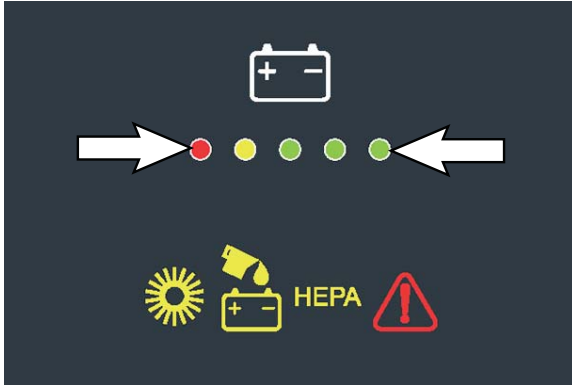

When the batteries are fully charged, all five indicators are illuminated. Recharge the batteries when there is only one indicator illuminated. Do not allow the batteries to discharge below 20% (last indicator).

NOTE: The reading on the battery discharge indicator is not accurate when the machine is first powered on. Operate the machine a few minutes before reading the charge level of the batteries.

NOTE: Lithium-ion Battery Model - Do not store the machine for an extended period if battery is discharged to the last bar, the battery may further discharge to a level that is unrecoverable.

WORN BRUSH INDICATOR

The *worn brush indicator* flashes when the main brush motor detects the main brush is worn. For best sweeping performance it is recommended that the main sweeping brush always be replaced as soon as possible when the *worn brush indicator* is flashing. The *worn brush indicator* will eventually illuminate solid if the main sweeping brush is not changed when the indicator is flashing, and sweeping performance will continue to deteriorate. See *REPLACING THE MAIN SWEEPING BRUSH* in the *MAINTENANCE* section for instructions how to change the main sweeping brush.



SMART-FILL ABW (AUTOMATIC BATTERY WATERING INDICATOR) (OPTION)

The *Smart-Fill ABW indicator* illuminates when there is not adequate water in the tank to fill the batteries. All sweep functions will cease operating and will remain inoperable if the machine is operated for 10 hours past when the indicator light is initially illuminated. See *SMART-FILL ABW (AUTOMATIC BATTERY WATERING) SYSTEM* in the *MAINTENANCE* section for instructions how to fill the tank.



OPERATION

HEPA (HIGH EFFICIENCY PARTICULATE ARRESTANCE) INDICATOR (MACHINES EQUIPPED WITH HEPA FILTRATION SYSTEM OPTION ONLY)

The *HEPA indicator* illuminates when the HEPA filter needs to be replaced due to excessive blockage preventing air from moving through the filter. For best sweeping performance, always replace the HEPA filter as soon as possible when the *HEPA indicator* is illuminated. See *REMOVING / REPLACING THE HOPPER DUST FILTER* in the *MAINTENANCE* section for instructions how to replace the HEPA filter.

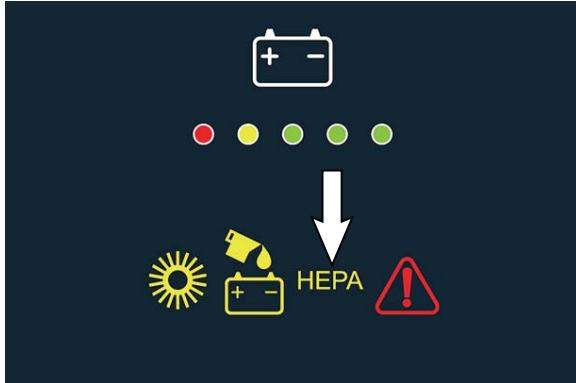

FAULT INDICATOR

The fault indicator illuminates when a fault code is detected. See *FAULT / ALERT CODES AND INDICATORS* for additional fault code information.



HOUR METER

The *hour meter* records the hours the machine was operated. Use this information to determine machine service intervals.



1-STEP BUTTON

Press the *1-STEP button* to activate all selected sweeping functions. Prior to the *1-STEP button* being pushed, the lights above all the selected sweeping functions will be on but the selected functions will be in the standby mode until the *1-STEP button* is pressed. Press the *1-STEP button* again when finished cleaning to stop all sweeping functions.

The indicator light in the button will illuminate when the *1-STEP button* is activated.



HOPPER SAFETY BUTTON

The *hopper safety button* must be pressed and held the entire time the hopper is either raising or lowering. The *hopper raise / lower switch* will not function to raise or lower the hopper if the *hopper safety button* is not pressed. The hopper will stop raising/lowering if the *hopper safety button* is released at anytime while the hopper is raising or lowering.



VACUUM FAN BUTTON

Turn on the vacuum fan: Press the *sweeping vacuum fan button*. The lower light will illuminate.

Adjust the vacuum fan to highest setting: Press the *sweeping vacuum fan button again*. The upper and lower indicator lights will illuminate.

Turn off the vacuum fan: Press the *sweeping vacuum fan button*. Both indicator lights will be off.

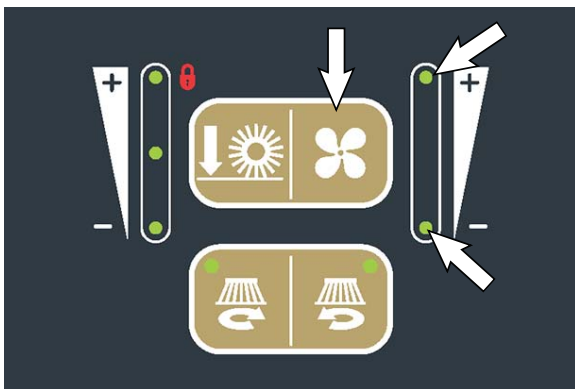

LEFT AND RIGHT SIDE BRUSH BUTTONS

Turn on the left side brush (option): Press the *left side brush button*. The indicator light will illuminate.

Turn off the right side brush: Press the *right side brush button*. The indicator light will turn off.

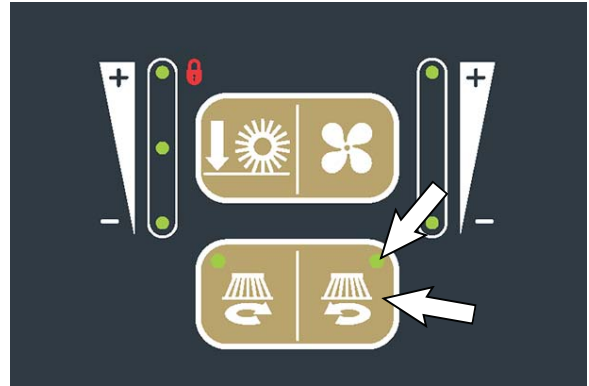

Turn on the left side brush: Press the *left side brush button*. The indicator light will illuminate.

Turn off the left side brush: Press the *left side brush button*. The indicator light will turn off.

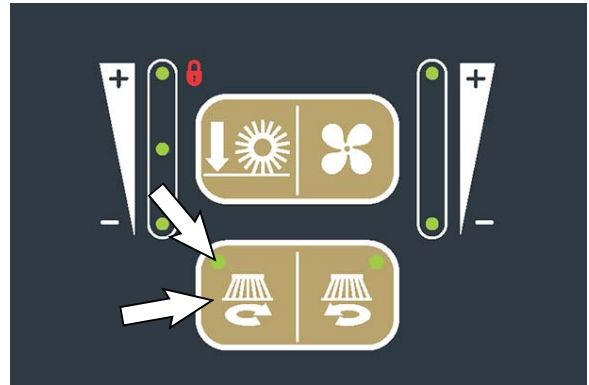

NOTE: The side brush(es) cannot operate independently from the main brush. The main brush also comes on with the side brush(es) when the 1-Step button is pressed.

OPERATION

ECO (ECONOMY) MODE BUTTON

Use the *Eco (economy) mode button* to extend the run time for the machine. While in the Eco mode all the voltages to the various motors are lowered, extending machine run time and lowering noise levels.

Turn on the Eco mode: Press the *Eco mode button* to place the machine into the Eco mode (lowest fan speed and lowest brush pressure settings) mode. The Eco indicator light will illuminate.

Turn off the Eco mode: Press the *Eco mode button* to return the machine to the previous settings. The indicator light will turn off.

NOTE: The vacuum fan can be turned off while the machine is in the Eco mode, but the machine will exit the Eco mode if the brush pressure is changed.

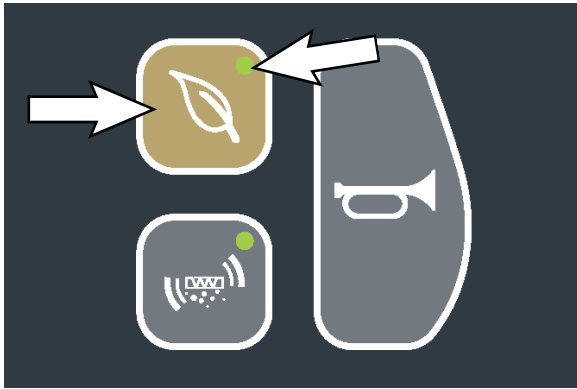

FILTER SHAKER BUTTON

Press the *filter shaker button*. The filter shaker will operate for 30 seconds.

The *filter shaker button* light will illuminate while the filter shaker is operating. Press the *filter shaker button* again if necessary to stop the filter shaker.

NOTE: If the hopper filter becomes clogged while the machine is sweeping, the filter shaker light will flash slowly to indicate that the filter needs to be shaken.

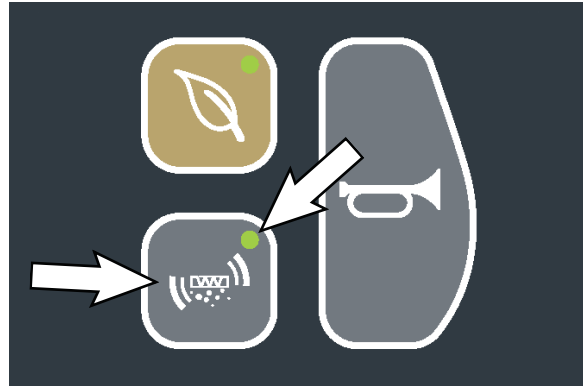

NOTE: If the machine has been continuously sweeping for 30 minutes or more the filter shaker will automatically shake the filter when the 1-Step button is pressed to turn off the sweep systems.

NOTE: Filter shaker will not function if hopper is raised. The hopper must be completely lowered for the filter shaker to function.

EMERGENCY SHUT-OFF BUTTON

The *emergency shut-off button* immediately stops the machine.

NOTE: *Steering wheel must be turned completely to either the right or the left if the machine is stopped on a grade.*

Stop machine power: Push the *emergency shut-off button*.

Restart machine power: Turn the *emergency shut-off button* to the right to release the button. Turn the key switch to the OFF position, then turn the key fully clockwise and release it to the ON position.

NOTE: *Lithium-ion Battery Model - To restart machine, turn key switch off and wait up to 3 seconds for machine power to completely shut off then turn key switch back on again.*

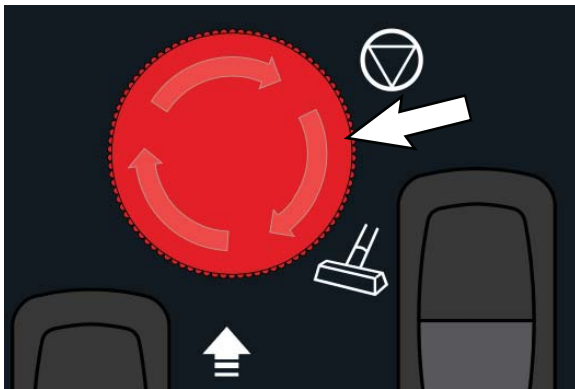

Only use this button in the event of an emergency. It is not intended for routine machine shutdown.

DIRECTIONAL SWITCH

Use the *directional switch* to select either the forward or reverse direction. Press the *propel pedal* to move the machine.



NOTE: *An audible alert will sound when the directional switch is placed into reverse.*

NOTE: *Machines equipped with the optional flashing light / backup alarm only: The optional backup light and alarm will function only when the machine is moving in reverse.*

OPERATING / HAZARD LIGHT SWITCH (OPTION)

Operating and Hazard Lights On: Press the top of the *operating / hazard light switch*.

Hazard Lights On: Press the *operating / hazard light switch* to the middle position.

All Lights Off: Press the bottom of the *operating / hazard light switch*.

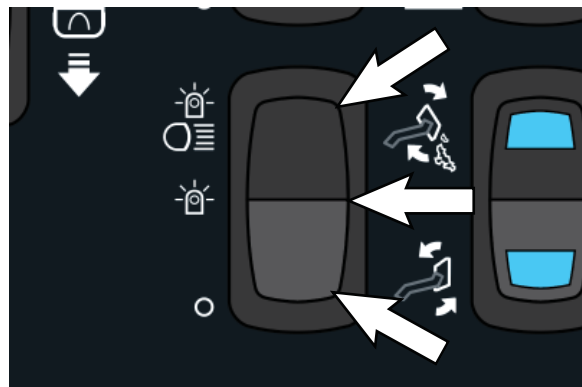

OPERATION

PROPEL PEDAL

Press the *propel pedal* to move the machine.

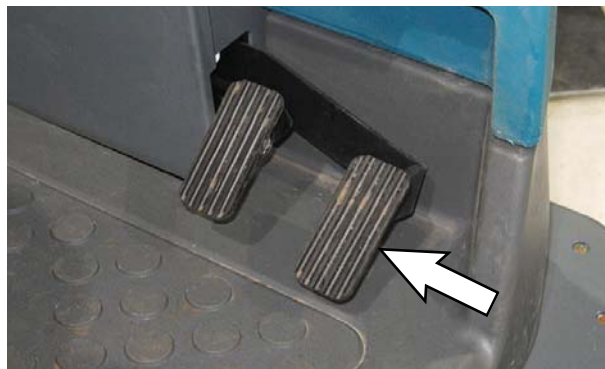

BRAKE PEDAL

Press the *brake pedal* to stop the machine.

NOTE: Steering wheel must be turned completely to either the right or the left if the machine is stopped on a grade.

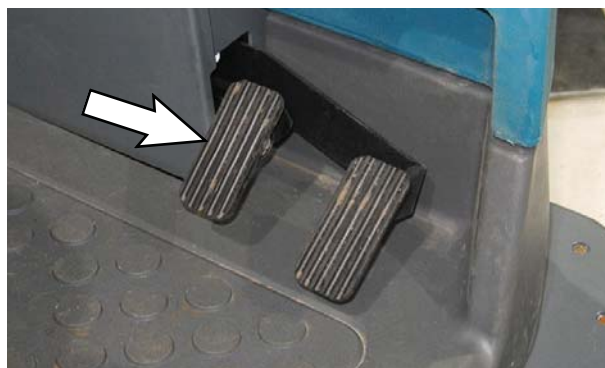

LARGE DEBRIS FLAP TRAP PEDAL

The *large debris flap trap pedal* opens the trap flap in front of the main sweeping brush.

Open: Press the pedal when sweeping larger debris. The flap in front of the main sweeping brush will open.

Close: Release the pedal and the flap will close, trapping larger debris to be swept into the hopper.

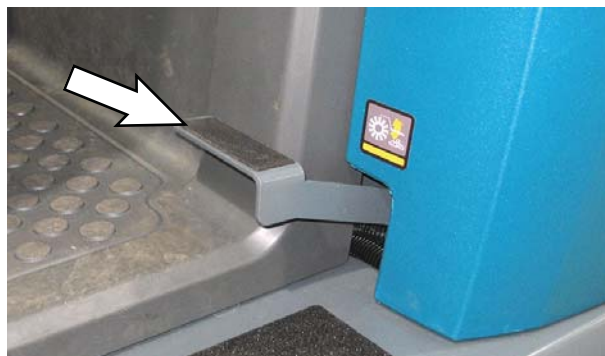

OPERATOR SEAT

The *front-to-back adjustment lever* adjusts the seat position.



SEAT BELTS (Deluxe Seat Option Only)

FOR SAFETY: Before starting machine, adjust seat and fasten seat belt.



SEAT SUPPORT

The *seat support* holds the seat up to allow access to the batteries.

To engage the *seat support*, lift the seat completely open until the pin slides into the lower notch of the seat support

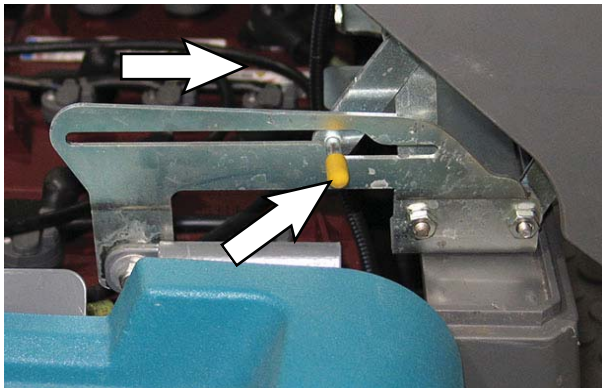
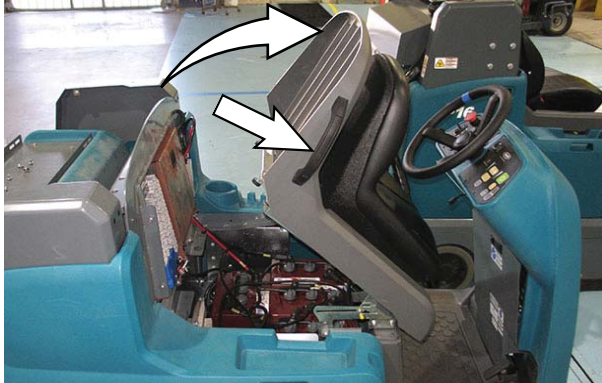

Machines with deluxe seat option only: Pull and hold the *operator seat release handle* forward to unlock the seat before lifting the seat open.

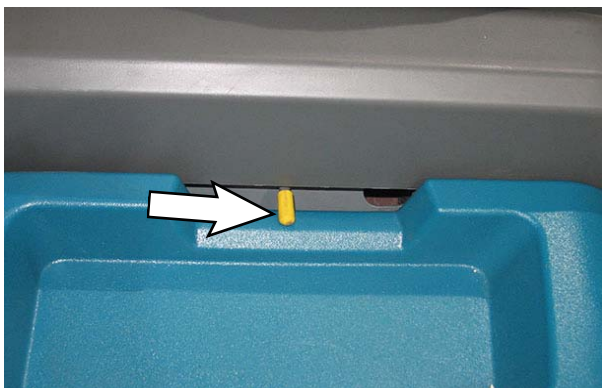

HOW THE MACHINE WORKS



The *1-STEP* button makes it possible to immediately begin sweeping by operating all the sweeping functions.

When the sweep mode is functioning the side brushes sweep debris into the path of the main sweeping brush. The main brush sweeps debris from the floor and into the hopper. The vacuum system pulls dust through the filtration system.

The machine also has an optional dry sweeping HEPA filtration system to help contain fine dust.

BRUSH INFORMATION

For best results, use the appropriate brushes for the cleaning application. Listed below are brushes and the applications for which each is best suited.

NOTE: The amount and type of soilage play an important role in determining the type of brush to use. Contact a Tennant representative for specific recommendations.

Polypropylene Sand Wedge Main Brush –

Recommended for heavy accumulation of sand and other fine particles.

Polypropylene Window Main Brush –

Recommended for light litter, especially on smooth floors.

Polypropylene 6-double row Main Brush –

Recommended for general sweeping applications.

Polypropylene and Wire 6-double row Main

Brush – Recommended for general sweeping and slightly impacted debris.

Natural Fiber 8-single row Main Brush –

Recommended for carpeted and artificial turf surfaces.

Polypropylene Side Brush – General purpose polypropylene bristles lift lightly compacted dirt without scuffing high-gloss coated floors.

WHILE OPERATING THE MACHINE

Pick up oversized debris before sweeping. Pick up wire, string, twine, large pieces of wood, or any other debris that could become wrapped around or tangled in the brushes.

Drive in as straight a path as possible. Avoid bumping into posts or scraping the sides of the machine. Overlap the sweep paths by several centimeters (a few inches). To avoid damaging carpeted surfaces, do not turn the steering wheel from side to side while the machine is setting still.

Avoid turning the steering wheel too sharply when the machine is in motion. The machine is very responsive to the movement of the steering wheel. Avoid sudden turns, except in emergencies.

Adjust the machine speed and brush pressure as required when sweeping. Use the appropriate brush pressure setting(s) for the area(s) being swept.

If poor cleaning performance is observed, stop cleaning and refer to MACHINE TROUBLESHOOTING in this manual.

Perform the Daily Maintenance Procedures after each use (see MACHINE MAINTENANCE in this manual).

Drive the machine slowly on inclines. Use the brake pedal to control machine speed on descending inclines. Sweep with the machine up inclines rather than down inclines.

NOTE: Steering wheel must be turned completely to either the right or the left if the machine is stopped on a grade.

FOR SAFETY: When using machine, go slowly on inclines and slippery surfaces.

Do not operate machine in areas where the ambient temperature is above 43° C (110° F). Do not operate sweeping functions in areas where the ambient temperature is below freezing 0° C (32° F).

FOR SAFETY: When using machine, do not sweep on ramp inclines that exceed 14.1% / 8° grade. Do not transport on ramp inclines that exceed 21.3% / 12° grade.

PRE-OPERATION CHECKLIST

Perform the following steps before operating the machine:

- Check for fluid leaks (machines with battery watering system and / or High Dump only).
- Check the hydraulic fluid level (High Dump only).
- Check the condition of the hopper dust filter and seals.
- Clean the hopper and the debris screen.
- Check all main brush compartment skirts for damage and wear.
- Check main brush for wear and damage. Remove wire, string, or twine wrapped around the main brush.
- Check side brush(es) for wear and damage. Remove wire, string, or twine wrapped around the brush(es).
- Machines with side brush skirts only: Check all side brush skirts for damage and wear.
- Check the hopper skirts and seals for damage and wear.
- Confirm the vacuum fan inlet filter is clean.
- Check the horn, headlights, taillights, safety lights, and backup alarm (if equipped).
- Check the brakes and steering for proper operation.
- Check the tires for damage.
- Check maintenance records to determine maintenance requirements.

OPERATION

TURNING ON THE MACHINE

FOR SAFETY: Before starting machine, adjust seat and fasten seat belt (if equipped).

1. Sit in the operators seat.
2. Turn the *key switch* ON.

NOTE: If the machine was just turned off, wait at least five seconds before restarting so that the software can fully reboot.

NOTE: Lithium-ion Battery Model - It is not required to turn the key switch completely past the On position to start machine. However, there is a slight delay before the machine power turns on after turning key switch. There is also a 3 second delay when powering off the machine.

NOTE: Lithium-ion Battery Model - The machine will automatically shut off if not operated for more than one hour to conserve battery energy. To restart machine, turn key switch off and wait up to 3 seconds before turning key switch back again.



3. Turn on lights (if equipped).
4. Place the *directional switch* into the direction needed to travel.
5. Press the *propel pedal* to move the machine.

NOTE: The machine will not travel unless the operator is sitting in the operator seat.

BRUSH PRESSURE

Under normal sweeping conditions and when sweeping carpeted surfaces, the brush pressure should be set to the lowest setting. Under heavier sweeping conditions, the brush pressure can be set to a higher setting. Travel speed and floor conditions will affect cleaning performance. If brushes are worn, it may be necessary to increase the brush pressure. The machine will default to the last setting used when it is powered on or off.

SETTING THE MAIN BRUSH PRESSURE

With the *1-STEP* button activated, press the *main brush pressure button* to both raise or lower the brush pressure settings. The brush pressure indicator lights display the current brush pressure setting.

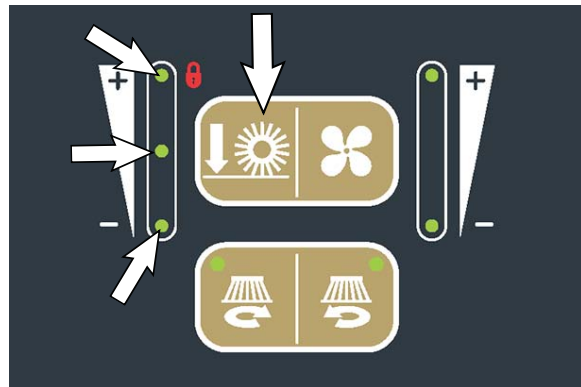

NOTE: To avoid damaging carpeted surfaces, always set the brush pressure to the lightest pressure setting when sweeping these surfaces.

SWEEPING

FOR SAFETY: Do not operate machine, unless operator manual is read and understood.

1. Turn the *key switch* ON.
2. If operating machine in the Eco mode: Press the *Eco mode button* to operate the machine in the Eco mode. The brush pressure and vacuum fan will go to the lowest settings.

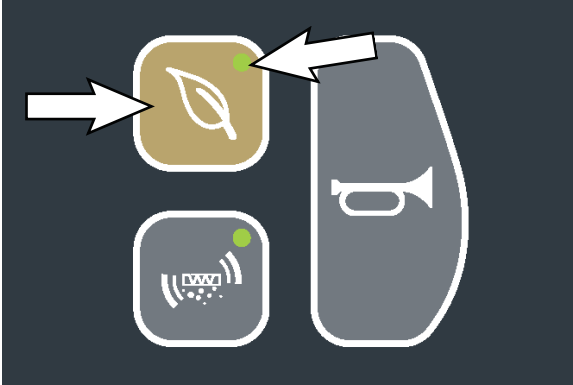

3. Press the *1-STEP button*. The light in the button will come on. All the preset sweeping functions will turn on.



4. If necessary, activate additional sweeping functions required for the area to be cleaned.

5. If necessary, adjust the brush pressure for the area being cleaned.

NOTE: To avoid damaging carpeted surfaces, always set the brush pressure to the lightest pressure setting when sweeping these surfaces.

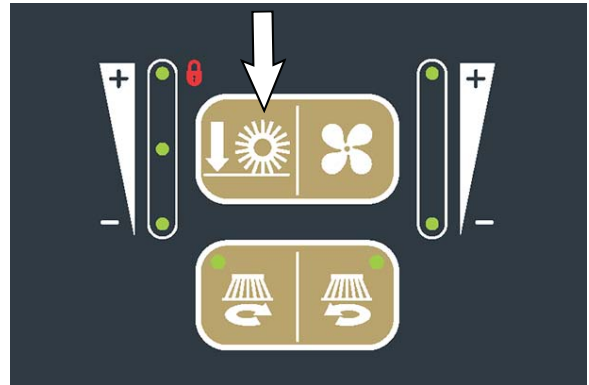

6. Place the *directional switch* in the forward position.



7. Press the *propel pedal* to begin sweeping.



WARNING: Flammable materials or reactive metals can cause an explosion or fire. Do not pick up.

FOR SAFETY: When using machine, go slowly on inclines and slippery surfaces.

OPERATION

8. Press down on the large debris trap pedal when sweeping large debris to raise the large debris trap skirt.

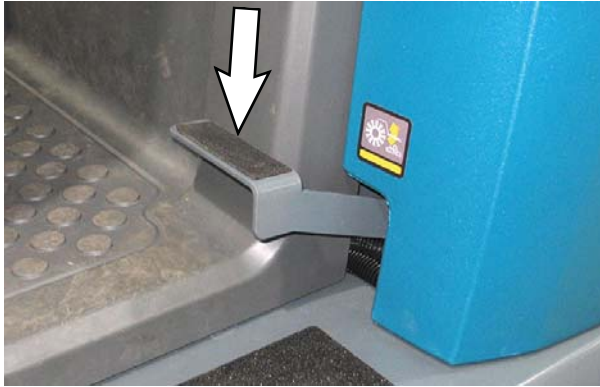

9. Release the large debris trap pedal to lower the large debris trap skirt, trapping the larger debris behind the skirt. The larger debris can then be swept into the hopper.

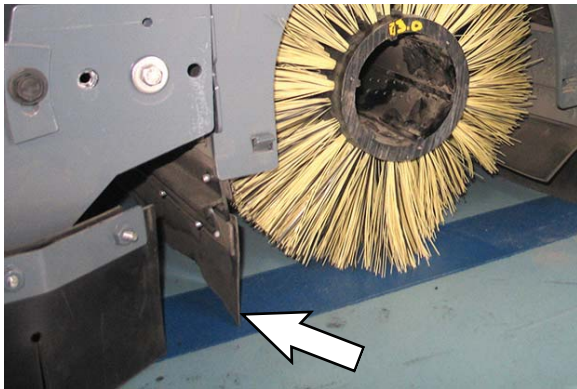

10. When finished sweeping, release the *directional pedal* and press the *brake pedal* to stop the machine.
11. Press the *1-STEP button* to stop sweeping. The light in the button will go off and the sweeping functions will stop after a short delay.



NOTE: If the machine has been continuously sweeping for 30 minutes or more the filter shaker will automatically shake the filter when the 1-Step button is pressed to turn off the sweep systems.

NOTE: If there is a fault or alert code during machine operation, stop the machine and refer to the FAULTS / ALERTS section of this manual for the cause and the corrective action for eliminating the fault or alert.

12. Empty the debris hopper at the end of each shift or as needed. See *EMPTYING THE HOPPER* section of this manual.

STOP SWEEPING

1. While the machine is still in motion, press the *1-STEP button* to stop cleaning.

NOTE: If the machine has been continuously sweeping for 30 minutes or more the filter shaker will automatically shake the filter when the 1-Step button is pressed to turn off the sweep systems.



2. Release the *propel pedal* and press the *brake pedal* to stop the machine.
3. Press the *filter shaker button* to clear dust and debris from the filter.

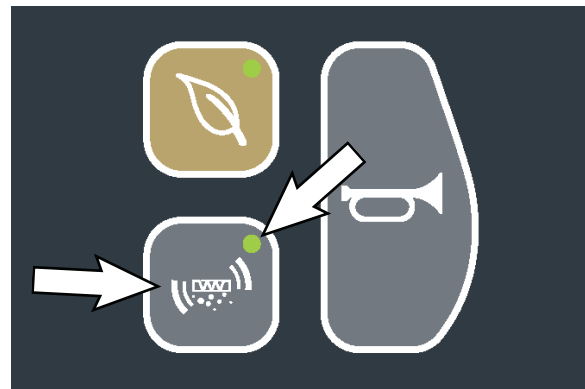

4. Empty the debris hopper at the end of each shift or as needed. See *EMPTYING THE HOPPER* section of this manual.

EMPTYING THE HOPPER

EMPTYING THE HOPPER (HIGH DUMP MACHINES)

1. Drive the machine to a debris site or container.
2. Press the *filter shaker button*. The shaker operates for approximately 30 seconds. The indicator light comes on while the filter shaker is operating. Press the *filter shaker button* again if necessary to stop the filter shaker.

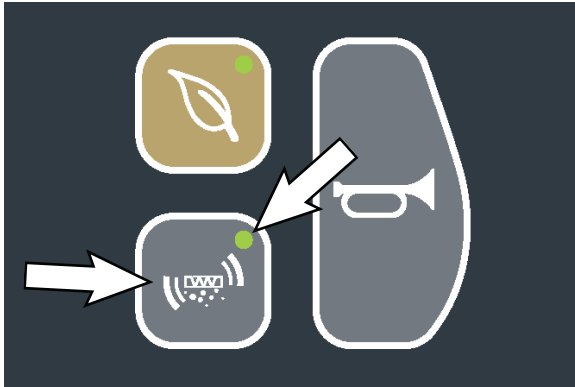

3. Turn off all cleaning functions before raising the hopper.
4. After the filter shaker stops, press and hold the *hopper safety button* and the top of the *hopper raise/lower switch* to raise the hopper. Release the button and switch when the hopper is at the desired position. The *hopper roll switch* lights illuminate when the hopper is raised enough to safely dump contents.

FOR SAFETY: When using machine, make sure adequate clearance is available before raising hopper. Do not raise hopper when machine is on an incline.

NOTE: Be aware the minimum ceiling height needed to raise the hopper is 2220 mm (87.4 in).

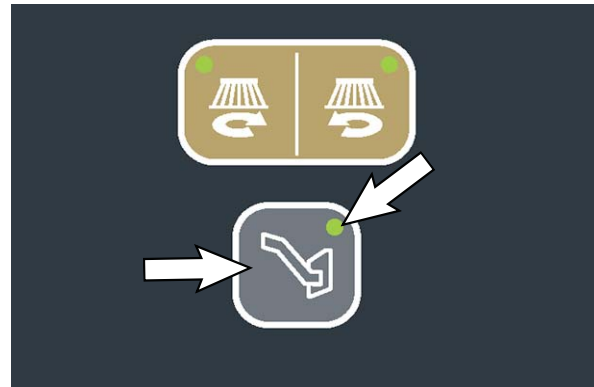
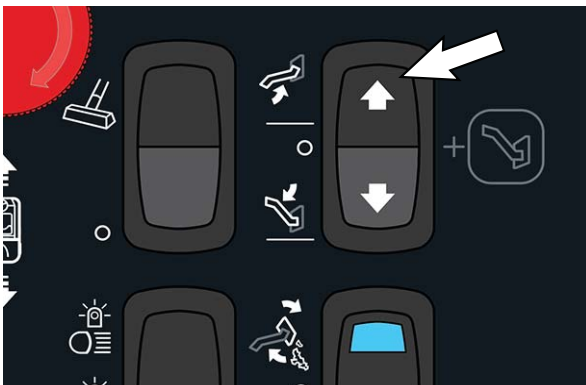

5. Slowly back the machine up to the debris container. Position the hopper over the debris container.
6. Press and hold the *hopper safety button* and the bottom of the *hopper raise/lower switch* to lower the hopper into the debris container to control dust.

FOR SAFETY: When using machine, use care when reversing machine. Move machine with care when hopper is raised.

7. Press and hold the top of the *hopper roll switch* to empty the contents from the hopper. The *hopper roll switch* lights will flash when the hopper is rolled out.



OPERATION

8. Press and hold the bottom of the *hopper roll switch* to return the hopper to the upright position.

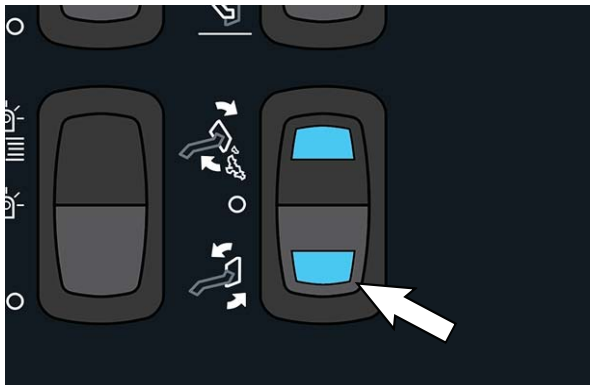

NOTE: If the hopper is not completely rolled in before it is lowered, the hopper will stop lowering, and completely roll in, before continuing to the completely lowered position.

9. Press and hold the *hopper safety button* and the top of the *hopper raise/lower switch* to raise the hopper enough to clear the top of the debris container.
10. Slowly drive the machine away from the debris site or container.
11. Stop the machine, then press and hold the *hopper safety button* and the bottom of the *hopper raise/lower switch* until the hopper is completely lowered.



EMPTYING THE HOPPER (LOW DUMP MACHINES)

1. Drive the machine to a debris site or container.
2. Press the *filter shaker button* to shake debris from filter. Press the top of the filter shaker switch again if necessary to stop the filter shaker.

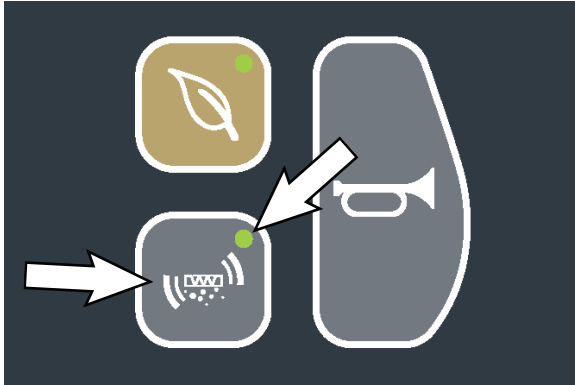

3. Turn off all cleaning functions.
4. Turn the *key switch* OFF.

FOR SAFETY: Before leaving or servicing machine, stop on level surface, turn off machine, and remove key.

5. Remove both pins from the hopper handle.



6. Adjust the *VarioHeight* hopper handle to the desired position and reinstall both pins into the hopper handle to secure handle in raised position.

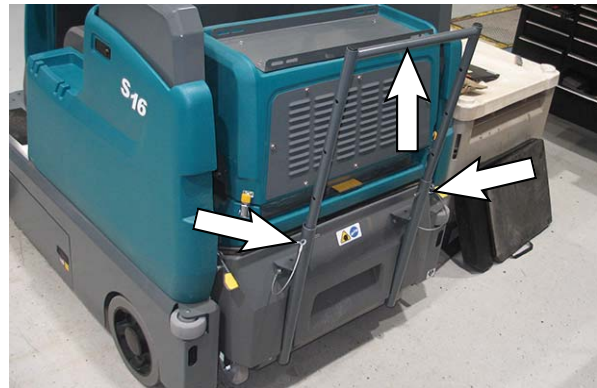

7. Squeeze both hopper retainer levers together and lift the hopper retainer latch from the hopper pin. Repeat to release the hopper retainer lever latch located on the other side of the hopper.

NOTE: If necessary, use the hopper handle to slightly push the hopper into the machine if the hopper is full.

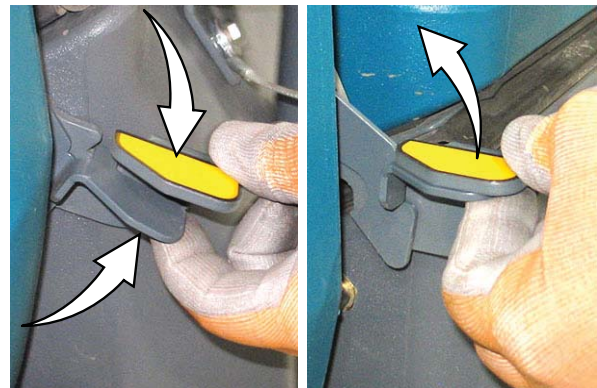

8. Pull on the hopper handle to roll the hopper out from the machine.



OPERATION

9. Roll the hopper to debris container and tip the hopper to empty the contents from the hopper.

FOR SAFETY: When using machine, use care when emptying hopper. Hopper can hold up to 91 kg (200 lbs). Lifting heavy material improperly can result in back strain or other personal injury.

10. Machines equipped with optional removable hopper bins only: Lift the bins from the hopper and empty the bins. Reinstall the bins into the hopper.



11. When finished emptying the hopper, roll the hopper back into the machine until the retainer lever latches secure the hopper to the machine.
12. Lower the hopper handle to the lowest position.

**ENGAGING THE HOPPER SUPPORT BAR
(HIGH DUMP MACHINES)**

1. Turn on the machine.

FOR SAFETY: When starting machine, keep foot on brake.

2. Completely raise the hopper.



WARNING: Lift arm pinch point. Stay clear of hopper lift arms.

FOR SAFETY: When using machine, make sure adequate clearance is available before raising hopper. Do not raise hopper when machine is on an incline.

NOTE: Be aware that the minimum ceiling height needed to raise the hopper is 2220 mm (87.4 in).

3. Turn the *key switch* OFF.
4. Remove the left shroud from the machine or pull the top of the left shroud away from the machine enough to allow access the hopper support bar.



5. Lift the hopper support bar onto the top of the hopper lift cylinder.

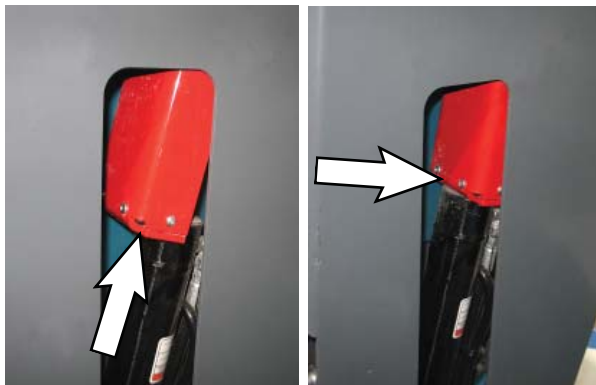

WARNING: Raised hopper may fall. Engage hopper support bar.

**DISENGAGING THE HOPPER SUPPORT BAR
(HIGH DUMP MACHINES)**

1. Lift hopper support bar from the top of the hopper lift cylinder and lower the hopper support bar against the side of the hopper lift cylinder.

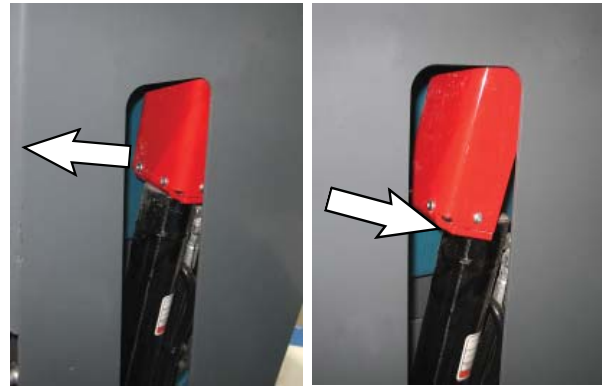

FOR SAFETY: When starting machine, keep foot on brake and directional pedal in neutral.

2. Reinstall/secure the left shroud onto the machine.
3. Turn the *key switch* ON.
4. Completely lower the hopper.



WARNING: Lift arm pinch point. Stay clear of hopper lift arms.

OPERATION

TURNING OFF THE MACHINE

1. Remove foot from the *propel pedal*.
2. Press the *1-STEP button* to stop sweeping.
3. Press the *brake pedal* to stop the machine.
4. Turn the *key switch* OFF and remove the key.

FOR SAFETY: Before leaving or servicing machine, stop on level surface, turn off machine, and remove key.



All the guards, covers, and seat must be down or closed and must be secured in their respective down or closed positions before water is used to clean the machine. Do not allow the hopper dust filter or HEPA filter to get wet.

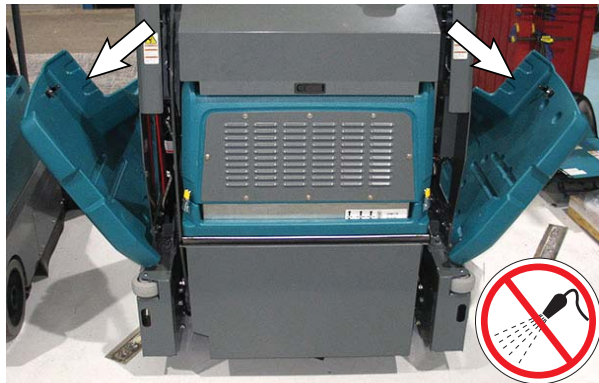

CLEANING THE MACHINE

The exterior of the machine can be cleaned with a low pressure water spray (garden hose). **Do Not** clean the machine with a high pressure washer or other high pressure spray.

FOR SAFETY: When servicing machine, do not power spray or hose off machine near electrical components.

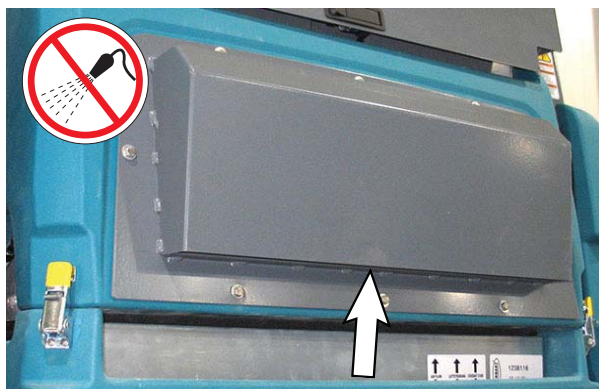

FAULT / ALERT CODES AND INDICATORS

FAULTS / ALERTS INDICATOR CODES

When the machine or battery charger detects a fault, the service indicator and a series of LED lights will flash.

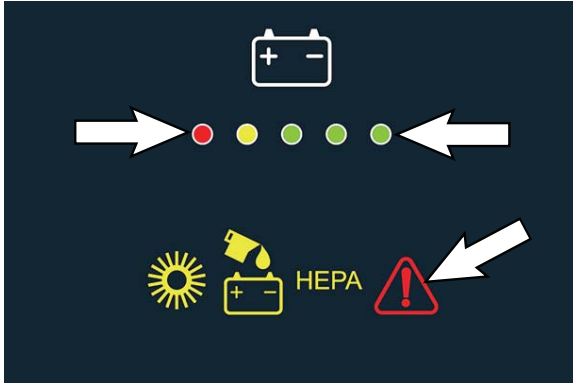

To reset the fault / alert indicators, turn off the machine and eliminate the cause of the fault / alert. The fault / alert and will reset when the machine is again turned on.

NOTE: Lithium-ion Battery Model - To clear fault code, turn the key switch off and wait up to 3 seconds for machine power to completely shut off. Then turn key switch back on again.

Refer to the fault / alert indicators table to determine the cause and remedy for the fault / alerts.

OPERATION

MACHINE SERVICE INDICATOR CODES

LED Fault Code ☀ = Flashing	Fault Code	Cause(s)	Remedy
☀☀☀☀☀	0xFFFO	Emergency stop button engaged	Release Emergency Stop button and key cycle machine to clear fault
☀☀●☀●	0x0B06	Battery water tank empty warning	Fill automatic battery watering tank.
●●●●☀	0x07A1	Hopper fire	Shut off machine. Extinguish fire. If necessary, call emergency personnel. <i>Note: Horn sounds when this fault occurs. Press horn button to silence horn.</i>
●☀☀●●	0x0F101	Charger no load warning	Verify charger is connected to batteries.
●●☀☀☀	0x0F102	Charger overheat warning.	Move machine to well ventilated area for charging
☀●●☀☀	0x0133	Main sweep motor over current fault	Check for debris obstructing brush/brush motor. Remove debris. Contact qualified Tennant service representative if problem persists.
	0x0134	Main sweep motor DP over current fault	
	0x0135	Main sweep motor SW over current fault	
	0x0153	Right sweep motor over current fault	
	0x0154	Right sweep motor DP over current fault	
	0x0155	Right sweep motor SW over current fault	
	0x0163	Left sweep motor over current fault	
	0x0164	Left sweep motor DP over current fault	
	0x0165	Left sweep motor SW over current fault	
	0x0173	Filter/shaker motor over current fault	Verify shaker motor rotates freely. Remove obstructions preventing shaker motor from rotating. Contact qualified Tennant service representative if problem persists.
	0x0174	Filter/shaker motor over current 1 fault	
	0x0175	Filter/shaker motor over current 2 fault	
	●☀☀●☀	0x0238	Main sweep actuator stalled
0x0248		Right side sweep actuator stalled	
0x0258		Left side sweep actuator stalled	
0x0268		Hopper lift actuator stalled	
0x0278		Hopper roll actuator stalled	
☀●●●☀	0x0980	Propel generic	Key cycle machine to clear fault. Check circuit breaker 1 (CB1). Reset circuit breaker if tripped. Contact qualified Tennant service representative if problem persists.
	0x09E3	Propel controller error	
●☀☀☀●	0x0B04	Battery watering system CAN fault	Key cycle machine to clear fault. Contact qualified Tennant service representative if problem persists.
	0x0D34	Lithium-ion battery pack BMS CAN fault	
	0x0F103	Battery charger CAN communication fault	
	0xFF20	Main sweep board CAN fault	
	0x09F0	Propel communication lost warning	

NOTE: Contact a Tennant Service representative for all other fault codes.

**ON-BOARD BATTERY CHARGER SERVICE
INDICATOR CODES**

LED Fault Code ☼ = Flashing	Fault Code	Cause(s)	Remedy
☼☼☼●●	0xF100	Charger error condition.	Contact service.
	0xF104	Batteries unable to charge correctly.	Contact service.
●☼☼●●	0xF101	Charger is not connected to battery pack.	Check cable connections. If fault code persists, contact service.
●☼●●●	0xF102	Charger overheated.	Let charger cool. Move to well ventilated area. If fault persists, contact service.
●☼☼☼●	0xF103	Charger communication fault.	Power cycle machine. If fault code persists, contact service.

OPERATION

LITHIUM-ION BATTERY SYSTEM SERVICE INDICATOR CODES

LED Fault Code ☼ = Flashing ○ = Solid red	LCD Fault Code	Cause(s)	Solution
○ ☼ ☼ ☼ ☼ ●	0x0D00 0x0D0A 0x0D17→0x0D19 0x0D1A 0x0D0B 0x0D0F 0x0D20→0x0D29 0x0D2A 0x0D2B 0x0D35	Battery management system (BMS) hardware fault	Contact service
○ ☼ ☼ ☼ ●	0x0D03	BMS over current charge protection	Unplug charger from AC power, wait 2 minutes and re-plug in charger. If fault code repeats, contact service.
	0x0D04 0x0D05 0x0D15 0x0D16 0x0D24	BMS over current fault	Look for obstruction and restart machine. If fault code repeats, contact service.
○ ☼ ☼ ● ☼	0x0D01 0x0D0B 0x0D0D 0x0D0E 0x0D36	BMS over current fault	Stop charging. Restart machine. If fault code repeats, contact service.
	0x0D02 0x0D0C 0x0D0F	BMS over current fault	Stop use of machine and recharge battery.
	0x0D1C 0x0D1D 0x0D1E	BMS cell deep discharge fault BMS cell imbalance fault BMS Module voltage delta error	Contact service.
○ ● ☼ ☼ ☼	0x0D34	BMS CAN communication lost	Restart machine. If fault code repeats, contact service
○ ● ● ● ☼	0x0D06 0x0D11 0x0D38	BMS over temperature protection fault	Stop charging. Move machine to cooler location. Allow battery to cool down before charging. If fault code repeats, contact service.
	0x0D07 0x0D12 0x0D37	BMS under temperature protection fault	Stop charging. Move machine to warmer location. Allow battery to warm up above 32°F/0°C before charging. If fault code repeats, contact service.
	0x0D08 0x0D10 0x0D13 0x0D3A	BMS over temperature discharge fault	Stop operating machine. Move machine to cooler location. Allow battery to cool down before operating. If fault code repeats, contact service.
	0x0D09 0x0D14 0x0D39	BMS under temperature discharge fault	Stop operating machine. Move machine to warmer location. Allow battery to warm up above 32°F/0°C before operating. If fault code repeats, contact service.
	0x0D31 0x0D32 0x0D33	BMS Bus Bar temperature fault	Stop operating or charging machine. Allow battery to cool down. If fault code repeats, contact service.

OPTIONS

VACUUM WAND (OPTION)

Use the vacuum wand to clean areas that are out of reach of the machine.



WARNING: Flammable materials or reactive metals can cause an explosion or fire. Do not pick up.

FOR SAFETY: Before leaving or servicing machine and stop on level surface.

1. Turn the machine on.
2. Press the top of the *vacuum wand* switch to place the vacuum wand system on standby.



3. Wand On: Lift the vacuum wand from the storage bracket. The vacuum wand will turn on.



4. Use the vacuum wand to clean.
5. Wand Off: Return the vacuum wand to storage bracket and the vacuum wand will turn off.
6. Press bottom of *vacuum wand* switch to turn off the vacuum wand system.

BLUE PEDESTRIAN LIGHTS (OPTION)

The *blue pedestrian lights* shine onto the floor both out in front of the machine, and to the rear of the machine, to alert pedestrians the machine is near. The blue pedestrian lights automatically come on when the key switch is turned on. Position the front and rear blue lights so they illuminate far enough out from the machine to adequately alert pedestrians that machine is near.



OPERATION

ADJUSTING BACKUP ALARM VOLUME (OPTION)

FOR SAFETY: When using machine, follow site safety guidelines concerning backup alarms.

The backup alarm volume can be adjusted from 85–102 dB(A). To adjust the volume, lift the seat to the raised position, engage the seat support, and use the alarm volume knob to adjust the volume.

Increase volume: Turn the knob clockwise.

Decrease volume: Turn the knob counterclockwise.



MACHINE TROUBLESHOOTING

Problem	Cause	Remedy
Excessive dusting	Vacuum fan off	Turn on vacuum fan
	Hopper dust filter clogged	Shake and / or replace dust filter
	Brush skirts and dust seals worn, damaged, or out of adjustment	Replace or adjust brush skirts and/or brush seals
	Vacuum fan seal damaged	Replace vacuum fan seal
	Vacuum fan failure	Contact Tennant service representative
	Thermo-Sentry tripped	Allow Thermo-Sentry to cool
	Perma-Filter clogged	Clean Perma-Filter
Poor sweeping performance	Worn brush bristles	Replace brushes
	Debris caught in main brush drive mechanism	Remove debris from main brush drive mechanism
	Main and/or side brush drive failure	Contact Tennant service representative
	Hopper full	Empty hopper
	Large debris trap skirt worn or damaged	Replace large debris trap skirt
	Recirculation flap damaged	Replace flap
	Hopper seals worn or damaged	Replace seals
	Wrong sweeping brush	Contact Tennant service representative
	Side brush drive failure	Contact Tennant service representative
	Main brush drive failure	Contact Tennant service representative
Reduced run time	Battery not fully charged	Charge battery until the charger automatically turns off
	Defective battery	Replace battery
	Batteries need maintenance	See <i>BATTERIES</i> in <i>MAINTENANCE</i>
	Faulty battery charger	Replace battery charger
Sweeping functions do not turn on	Hopper is up	Completely lower hopper
	Fire in the hopper	Turn off machine. Extinguish fire. If necessary, call emergency personnel.
Poor vacuum wand vacuum performance	Vacuum bag is damaged or full	Replace vacuum bag
	Clogged hose	Remove clog
	Torn seals on dry vacuum system	Replace seals

HEPA FILTER SYSTEM TROUBLESHOOTING

Refer to the troubleshooting table below and the troubleshooting procedures if excessive dust is noted on machines equipped with the HEPA filter during machine operation.

Step	Action	Not Dusting	Dusting
1	* Use electric shaker to shake primary dust filter * Empty hopper	Resume Sweeping	Proceed to Step 2
2	* Inspect the hopper seals	Resume Sweeping	Proceed to Step 3
3	* Remove primary filter and place in plastic bag and manually tap filter to remove dust * Inspect seal on filter cover * Inspect seals located on top and bottom of hopper dust filter * Inspect seal to vacuum fan inlet	Resume Sweeping	Proceed to Step 4
4	* Inspect side brush dust control skirts for damage and adjustment	Resume Sweeping	Proceed to Step 5
5	* Inspect all outer sweep compartment skirts * Remove main sweep brush and inspect sweep chamber skirts	Resume Sweeping	Proceed to Step 8
6	* Remove HEPA filter and inspect fan plate seals	Resume Sweeping	

MAINTENANCE

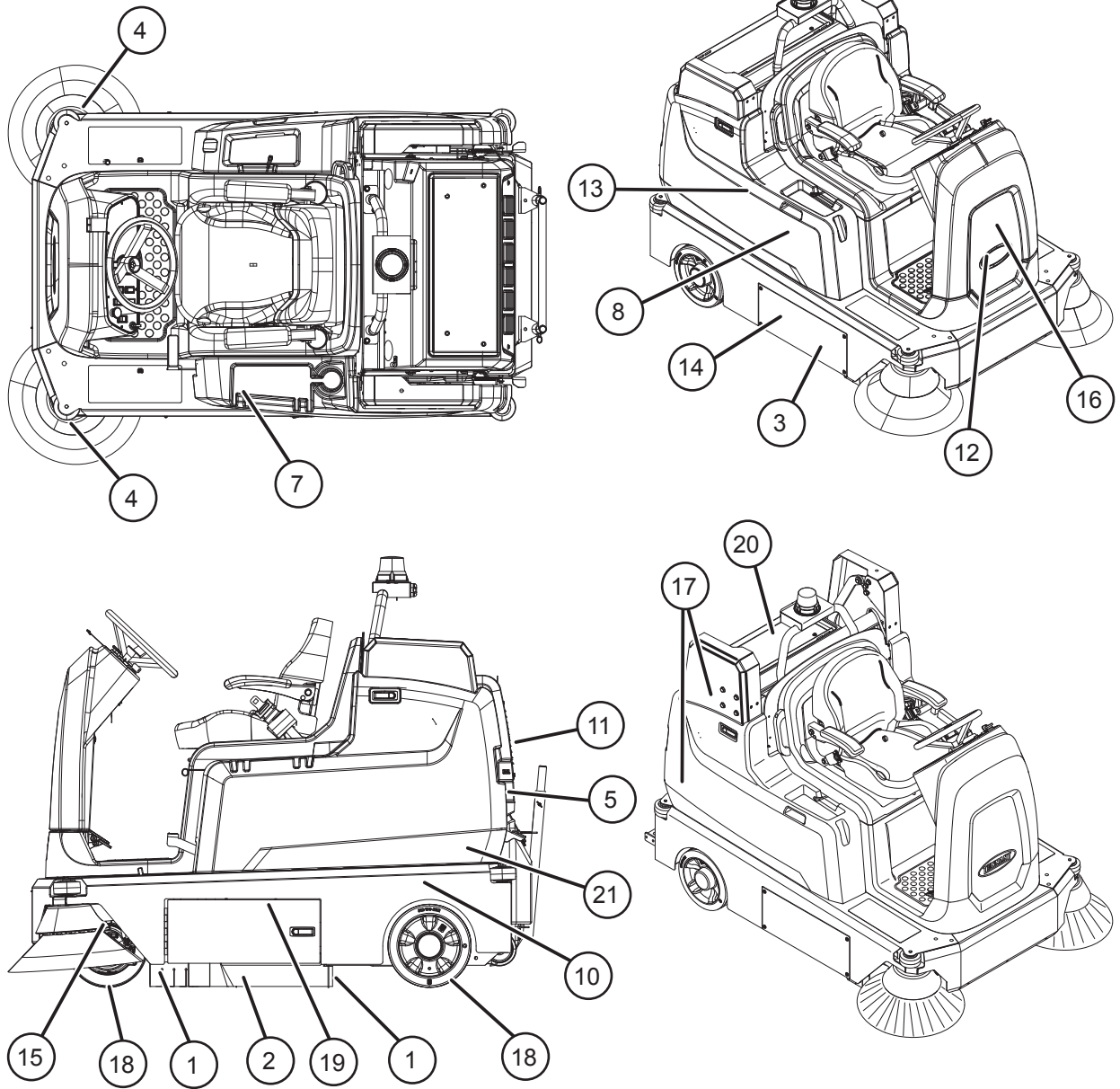

MAINTENANCE

MAINTENANCE CHART

The table below indicates the Person Responsible for each procedure.

O = Operator.

T = Trained Personnel.

 = Indicates unique maintenance schedule for machines equipped with HEPA filtration system.

Interval	Person Resp.	With HEPA	Without HEPA	Key	Description	Procedure	Lubricant/ Fluid	No. of Service Points
Daily / 8 Hours	O			7	Hydraulic reservoir (High Dump Machines Only)	Check hydraulic fluid level	HYDO	1
	O			1	Brush compartment skirts	Check for damage, wear and adjustment	-	5
	O	*		1	Brush compartment HEPA skirts	Check for damage, wear and adjustment	-	2
	O			2	Side skirts	Check for damage, wear and adjustment	-	2
	O			3	Main brush	Check for damage, wear, and debris	-	2
	O			4	Right side brush/ Left side brush (Option)	Check for damage, wear, debris	-	1 (2)
	O			-	Side brush dust control skirts (Option)	Check for damage, wear and adjustment	-	All
	O			5	Hopper dust filter	Shake to clean	-	1
	O	*		5	Hopper	Clean and rinse	-	1
	O	*		19	Main brush door HEPA seals	Check for damage and wear	-	1
	O			6	Vacuum wand bag (Option)	Clean	-	1
Weekly	T			8	Battery cells	Check electrolyte level	DW	All
	O			8	Battery compartment	Check for liquid. Drain if necessary	-	
50 Hours	O			3	Main brush	Rotate end for end	-	1
	O			-	Vacuum wand bag (Option)	Check or change vacuum bag	-	1
	O			-	Vacuum wand fan (Option)	Check for damage or wear	-	1

The table below indicates the Person Responsible for each procedure.

O = Operator.

T = Trained Personnel.

■ = Indicates unique maintenance schedule for machines equipped with HEPA filtration system.

Interval	Person Resp	With HEPA	Without HEPA	Key	Description	Procedure	Lubricant/ Fluid	No. of Service Points
100 Hours	T			8	Battery watering system (option)	Check hoses and connections for damage and wear		All
	O			5	Hopper dust filter	Change for damage, clean or replace		1
	O			10	Hopper seals	Check for damage or wear	-	6
	O			5	Hopper filter seals	Check for damage or wear	-	2
	O			21	Perma-Filter	Check for debris, clean as necessary		1
	O			5	Lint screen (option)	Check for debris, clean as necessary		
	O			11	Vacuum seal	Check for damage or wear	-	1
	O			1	Large debris trap skirt	Check for damage or wear	-	1
	O			14	Main brush drive belt	Check for wear	-	1
200 Hours	T			16	Steering chain	Lubricate and check for damage and wear.	GL	1
	O			4	Side brush(es) guard	Check for damage or wear	-	1 (2)
	T			8	Battery terminals and cables	Check and clean	-	All
	T			17	Hopper lift arm pivots (High Dump Machines Only)	Lubricate	SPL	3
500 Hours	O			18	Tires	Check for damage and wear	-	3
	T			20	Vacuum wand fan motor(s)	Check motor brushes	-	1
	T	*		11	HEPA vacuum fan motors	Check motor brushes	-	2

MAINTENANCE

The table below indicates the Person Responsible for each procedure.

O = Operator.

T = Trained Personnel.

 = Indicates unique maintenance schedule for machines equipped with HEPA filtration system.

Interval	Person Resp	With HEPA	Without HEPA	Key	Description	Procedure	Lubricant/ Fluid	No. of Service Points
800 Hours	T			-	Hydraulic hoses (High Dump Machines Only)	Check for wear and damage	-	All
1750 Hours	T			13	Vacuum fan motor	Check motor brushes	-	1
2400 Hours	T			7	Hydraulic reservoir (High Dump Machines Only)	Change hydraulic fluid	HYDO	1

LUBRICANT/FLUID

DW Distilled water.

SPL Special lubricant, Lubriplate EMB grease (Tennant part number 01433-1)

GL SAE 90 weight gear lubricant

HYDO **Tennant True** premium hydraulic fluid or equivalent

NOTE: More frequent maintenance intervals may be required in extremely dusty conditions.

YELLOW TOUCH POINTS

This machine features easy to find yellow touch points for simple service items. No tools are required to perform these maintenance operations.

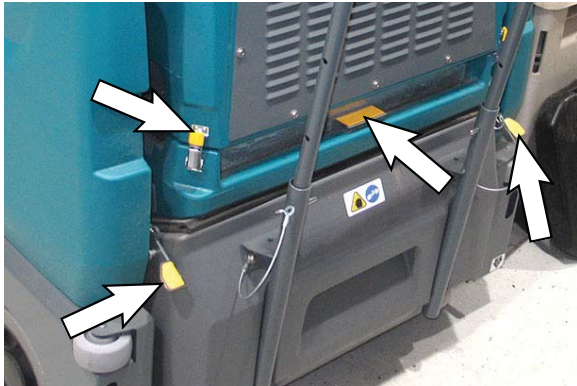

HOPPER LIFT ARM PIVOTS (HIGH DUMP MACHINES ONLY)

Lubricate the hopper lift arm pivots after every 200 hours of operation.

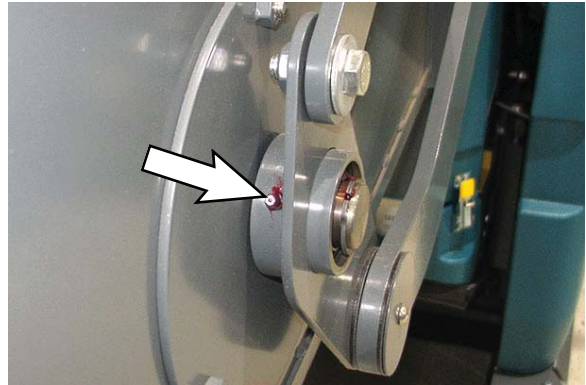

LUBRICATION

FOR SAFETY: Before leaving or servicing machine, stop on level surface, turn off machine, and remove key.

STEERING CHAIN

The steering chain is located directly above the drive wheel assembly. Check for damage or wear and lubricate the steering chain after every 200 hours.

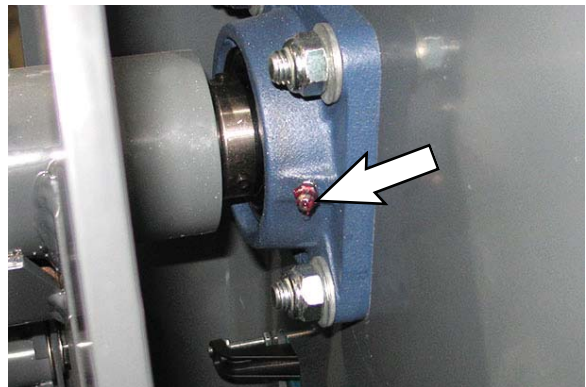
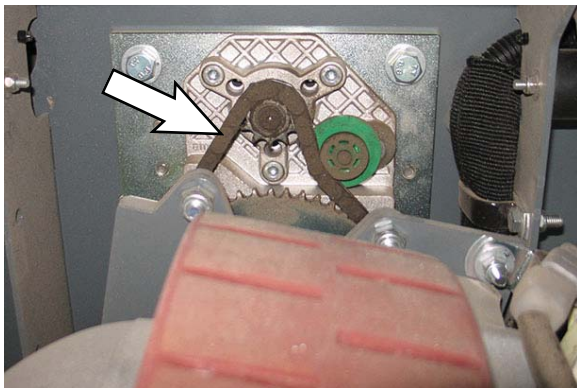
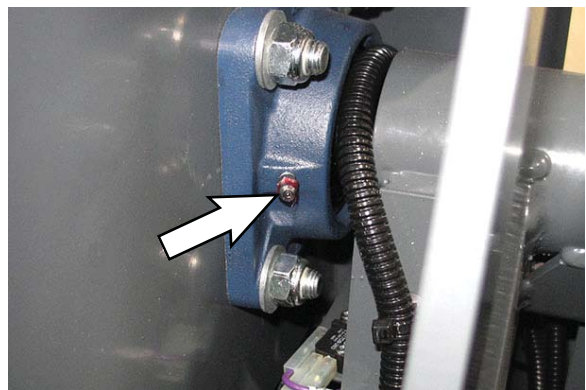

HYDRAULICS (HIGH DUMP MACHINES ONLY)

Check the hydraulic fluid level at operating temperature daily. The hydraulic fluid level should be between the MIN and MAX markings on the hydraulic reservoir. The hopper must be down when checking hydraulic fluid level.

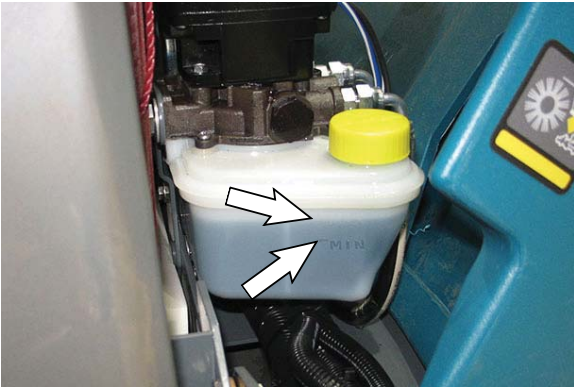

ATTENTION! Do not overfill the hydraulic fluid reservoir or operate the machine with a low level of hydraulic fluid in the reservoir. Damage to the machine hydraulic system may result.

Drain and refill the hydraulic fluid reservoir with new **TennantTrue** premium hydraulic fluid after every 2400 hours of operation.



HYDRAULIC FLUID

TennantTrue premium hydraulic fluid (Extended Life)		
Part Number	Capacity	ISO Grade Viscosity Index (VI)
1057707	3.8 L (1 gal)	ISO 32 VI 163 or higher
1057708	19 L (5 gal)	

If using a locally-available hydraulic fluid, be sure the specifications match Tennant hydraulic fluid specifications. Substitute fluids can cause premature failure of hydraulic components.

ATTENTION! Hydraulic components depend on system hydraulic fluid for internal lubrication. Malfunctions, accelerated wear, and damage will result if dirt or other contaminants enter the hydraulic system.

HYDRAULIC HOSES

Check the hydraulic hoses after every 800 hours of operation for wear or damage.

FOR SAFETY: When servicing machine, use cardboard to locate leaking hydraulic fluid under pressure.

High pressure fluid escaping from a very small hole can almost be invisible, and can cause serious injuries.

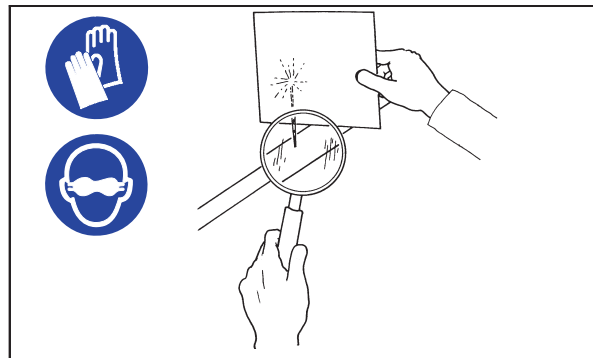

00002

Consult a physician immediately if injury results from escaping hydraulic fluid. Serious infection or reaction can occur if proper medical treatment is not given immediately.

Contact a mechanic or supervisor if a leak is discovered.

BATTERIES



FOR SAFETY: Before leaving or servicing machine, stop on level surface, turn off machine, and remove key.

FLOODED (WET) AND MAINTENANCE-FREE SEALED LEAD-ACID BATTERIES

The lifetime of the battery depends on proper maintenance. To get the most life from the battery:

- Do not charge the batteries more than once a day and only after running the machine for a minimum of 15 minutes.
- Do not leave the battery partially discharged for long period of time.
- Only charge the battery in a well ventilated area to prevent gas build up. Charge the battery pack in temperatures below 80°F/27°C and above 32°F/0°C.
- Allow the charger to completely charge the battery before reusing the machine.
- Maintain the proper electrolyte levels of flooded (wet) batteries by checking battery cell levels weekly.

NOTE: If machine is equipped with the automatic battery watering system, proceed to the SMART-FILL AUTOMATIC BATTERY WATERING SYSTEM.

CHECKING THE ELECTROLYTE LEVEL

The flooded (wet) lead-acid battery requires routine maintenance as described below. Check the battery electrolyte level weekly.

NOTE: Do Not check the electrolyte level if the machine is equipped with the battery watering system. Proceed to the BATTERY WATERING SYSTEM (OPTION).

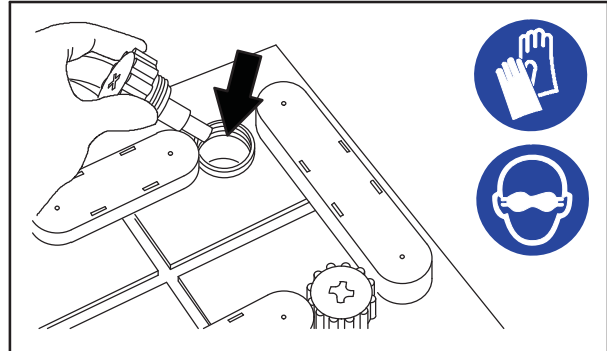

08247

FOR SAFETY: When servicing machine, keep all metal objects off batteries. Avoid contact with battery acid.

The level should be slightly above the battery plates as shown before charging. Add distilled water if low. **DO NOT OVERFILL.** The electrolyte will expand and may overflow when charging. After charging, distilled water can be added up to about 3 mm (0.12 in) below the sight tubes.

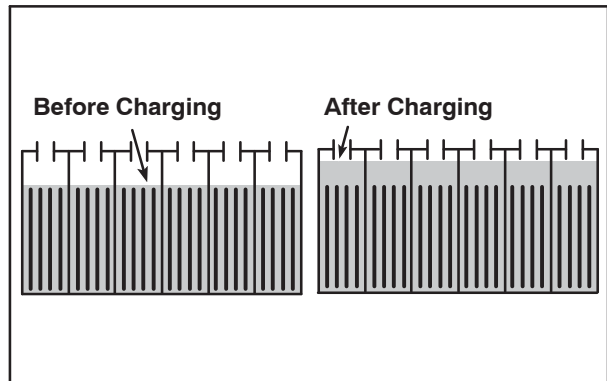

NOTE: Make sure the battery caps are in place while charging. There may be a sulfur smell after charging batteries. This is normal.

MAINTENANCE-FREE BATTERIES

Maintenance-free batteries do not require watering. Cleaning and other routine maintenance is still required.

CHECKING CONNECTIONS / CLEANING

After every 200 hours of use check for loose battery connections and clean the surface of the batteries, including terminals and cable clamps, with a strong solution of baking soda and water. Replace any worn or damaged wires. Do not remove battery caps when cleaning batteries.

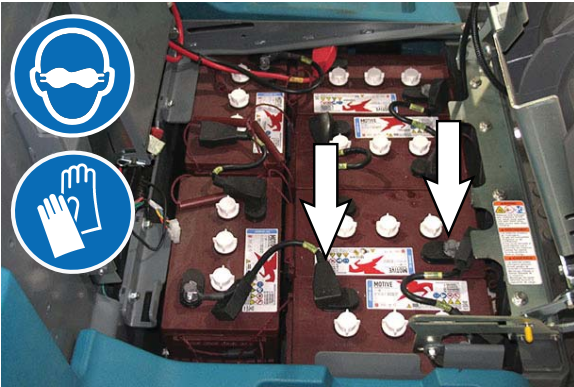

LITHIUM-ION BATTERY PACK

The lithium-ion battery pack is a maintenance-free battery protected by a battery management system (BMS). To achieve the maximum battery life, carefully follow the instructions below:

- Carefully follow the Important Safety Instructions section in the manual when using the Lithium-ion Battery Model.
- Only use the lithium-ion battery charger supplied with machine.
- Charge battery pack in well-ventilated areas. For best charging performance, charge the battery pack in temperatures below 80°F/27°C and above 32°F/0°C. Battery pack may shut down and not take a charge in elevated or freezing temperatures
- It is recommended to only recharge battery pack when the discharge level is fully depleted (i.e. when discharge indicator reaches red light). If the red light begins to flash, the scrub function will automatically be disabled. This allows the user to use the remaining power to propel the machine back to charging station. Do not store the machine for a long period at this depleted level, the battery pack may further discharge to a level that is unrecoverable.
- When the machine shuts down due to a depleted battery pack, do not repeatedly cycle the key on and off. This may cause permanent battery pack damage. Recharge battery pack immediately to avoid damage.
- Allow charge cycle to completely charge battery pack.
- Avoid frequent complete charge cycles if battery pack was not fully depleted.
- Opportunity charging (i.e. partial charge cycle of a half hour or more) is only recommended if discharge level is below 80% (i.e. when discharge indicator is at or beyond second green light).
- Do not operate machine in temperatures above 110°F / 43°C or below -4°F / -20°C. Machine may shutdown if exceed these temperatures.
- When removing or replacing the lithium-ion battery pack, use non-conductive lifting straps positioned at all four lift points with straps angled at 45° or greater when hoisting battery pack.
- Contact Tennant Service for lithium-ion battery service and replacement.

CHARGING THE BATTERIES

IMPORTANT: Before charging, make sure that the machine and charger settings are properly set for the battery type.

NOTE: Use a charger with the proper rating for the batteries to prevent damage to the batteries or reduce the battery life.

NOTE: Do not opportunity charge standard batteries since doing so can shorten battery life.

1. Park the machine on a flat, dry surface in a well-ventilated area.
2. Turn key switch OFF.

FOR SAFETY: Before leaving or servicing machine, stop on level surface, turn off machine, and remove key.

3. Lift the battery compartment cover open and engage the support.

NOTE: Make sure the batteries have the proper electrolyte level before charging. See CHECKING THE ELECTROLYTE LEVEL.

4. Machines with off-board chargers: Connect the charger connector to the machine off-board battery charging connector.

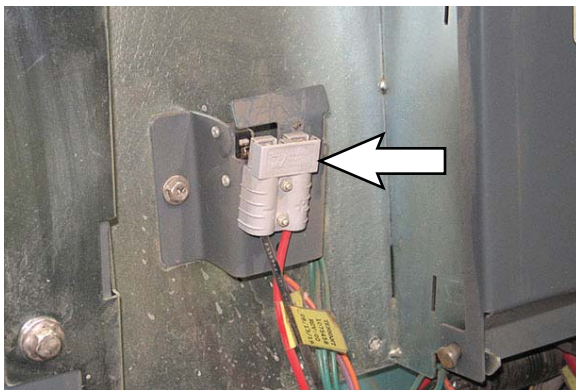

5. Plug the charger AC power supply cord into a properly grounded outlet.

6. The charger will automatically begin charging and shut off when fully charged. The maximum charging cycle may take up to 6-12 hours depending on battery type.

On-board battery charger: The battery discharge indicator lights will ripple back and forth during the charging cycle. When all five lights repeatedly flash two times, the charging cycle is complete

NOTE: The Lithium-Ion Battery Pack's battery management system (BMS) is active for five minutes after the machine cable is disconnected. If the charger is not connected and charging within this five minutes, the BMS will shut off and the charger will not be able to charge. Reconnect the machine cable to the battery pack and remove it again to restart the BMS active period.

FOR SAFETY: Do not disconnect the off-board charger's DC cord from the machine receptacle when the charger is operating. Arcing may result. If the charger must be interrupted during charging, disconnect the AC power supply cord first.

7. Machines with off-board chargers: After the batteries have completely charged, disconnect the AC power supply chord from the outlet and then disconnect the charger cable from the machine off-board battery charging connector.

NOTE: For models equipped with an off-board charger, always disconnect the AC power supply cord first before disconnecting charger from machine.

Machines with on-board chargers: After the batteries have completely charged, disconnect the AC power supply chord from the outlet and wrap the chord onto the storage hooks located on the battery compartment cover.

NOTE: Lithium-ion Battery Model - If the key is in the off position when charging (recommended), the battery discharge indicator will automatically shut off 5 minutes after the charge cycle has completed to conserve energy. To see the charge status, turn the key to the on position.

MAINTENANCE

ON-BOARD AND OFF-BOARD BATTERY CHARGER SETTINGS

NOTE: The following instructions are intended for the Delta-Q charger model RC-900-U36 supplied by Tennant.

NOTE: The Tennant Service Diagnostic tool must be used to change the on-board charger settings.

1. To display the current profile setting, press and release the Select Charge Profile Button. The profile setting is indicated by the number of consecutive green flashes after the initial two red flashes. This code is repeated twice.

ex. Profile Setting 3: ☼ ☼ ☼ ☼ ☼
(Flashes: Red-Red-Green-Green-Green)

ex. Profile Setting 4-3: ☼☼☼☼☼☼☼ || ☼☼☼☼
(Flashes: Red-Red, Green-Green-Green - Green - pause - Green-Green-Green)

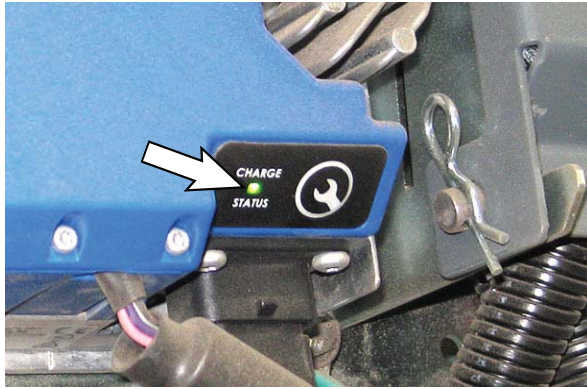

2. To enter the battery select mode to choose a new profile setting, press and hold the Select Charge Profile Button for 5 seconds. Fast red flashes will confirm select mode entry.

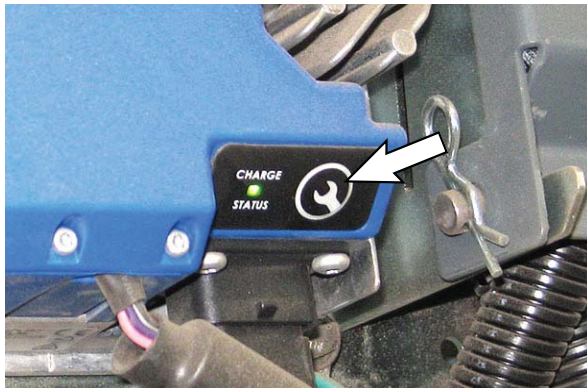

3. Indicator will then display current profile setting. This is repeated 4 times.

ex. Profile Setting 3: ☼ ☼ ☼ ☼ ☼
(Flashes: Red-Red-Yellow-Yellow-Yellow)

4. To change profile setting, press the Select Charge Profile Button while the current setting is repeating 4 times. Continue to press button until desired profile setting is flashing

Profile Setting	Battery Description
3	Wet, Trojan 180-240 AH
7	Wet, Trojan 270-360 AH
2-1	Wet, TAB/Energysys 180-260 AH
2-8	Gel, Deka 180-200 AH
4-3	AGM, Discover 200-400 AH
5-1	Gel, Sonnenschein 150-250 AH
1-6-8	TPPL, 12XFC48/12XFC58/12XFC60

5. To save new setting, press the button for 7 seconds until new setting is displayed by green flashes. The new setting will repeat two times with two red flashed between repeats.
6. Repeat Step 1 to confirm the new battery charger setting.

OPPORTUNITY CHARGING (LITHIUM-ION BATTERIES ONLY)

Opportunity charging is used to extend machine run time and productivity by allowing batteries to be charged during breaks, lunch, between shifts, or whenever there is an “opportunity” to charge.

Opportunity charging (i.e. partial charge cycle of a half hour or more) is only recommended if discharge level is below 80% (i.e. when discharge indicator is at or beyond second green light).



IMPORTANT: Before charging, make sure that the machine and charger settings are properly set for the battery type.

NOTE: The machine must be equipped with a lithium-ion battery or a battery capable of being opportunity charged. Do not opportunity charge standard batteries since doing so can shorten battery life.

1. Park the machine on a flat, dry surface in a well-ventilated area.
2. Turn key switch OFF.

FOR SAFETY: Before leaving or servicing machine, stop on level surface, turn off machine, and remove key.

3. Lift the battery compartment cover open and engage the support.

NOTE: The Lithium-Ion Battery Pack’s battery management system (BMS) is active for five minutes after the machine cable is disconnected. If the charger is not connected and charging within this five minutes, the BMS will shut off and the charger will not be able to charge. Reconnect the machine cable to the battery pack and remove it again to restart the BMS active period.

4. Machines with off-board chargers: Connect the charger connector to the machine off-board battery charging connector.



5. Plug the charger AC power supply cord into a properly grounded outlet.
6. The battery will be opportunity charged during the break.

FOR SAFETY: When servicing machine do not disconnect the off-board charger’s DC cord from the machine receptacle when the charger is operating. Arcing may result. If the charger must be interrupted during charging, press charger stop / start button to stop charger.

7. Machines with off-board chargers: When finished opportunity charging, disconnect the AC power supply chord from the outlet and then disconnect the charger cable from the machine off-board battery charging connector.

NOTE: For models equipped with an off-board charger, always disconnect the AC power supply cord first before disconnecting charger from machine.

Machines with on-board chargers: When finished opportunity charging, disconnect the AC power supply chord from the outlet and wrap the chord onto the storage hooks located on the seat shroud.

8. Close the battery compartment cover.

MAINTENANCE

MANUAL BATTERY WATERING SYSTEM

The following instructions are for models equipped with the manual battery watering system option.

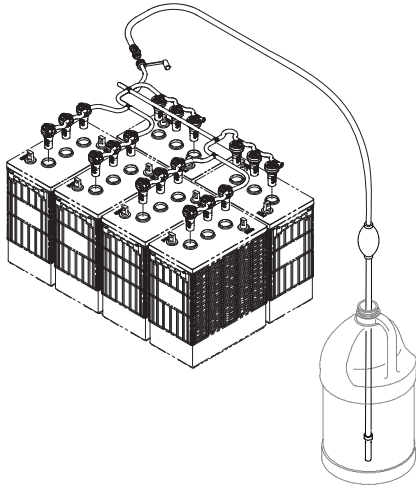

The optional manual battery watering system provides a safe and easy way to maintain the proper electrolyte levels in your batteries. It is designed exclusively for flooded (wet) lead-acid batteries.

FOR SAFETY: When servicing machine, wear personal protection equipment as needed. Avoid contact with battery acid.

Before using the battery watering system check hoses and connections for damage or wear.

1. Fully charge batteries prior to using the battery watering system. Do not add water to batteries before charging, the electrolyte level will expand and may overflow when charging.
2. After charging batteries, check the battery electrolyte level indicators located on the battery covers. If the level indicator is black add water as described in the following instructions. If the level indicators are white the electrolyte is at the correct level, no water is required.

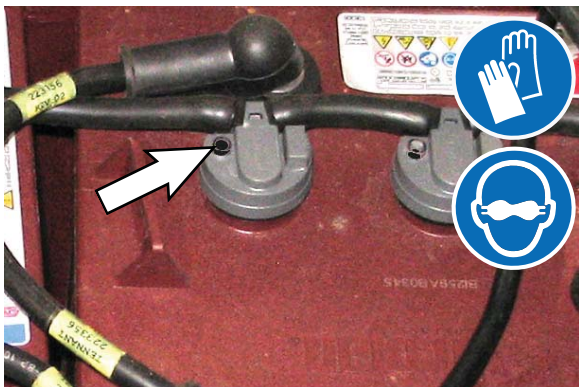

3. Locate the battery fill hose coupler inside the battery compartment. Remove the dust cap and connect the hand pump hose.

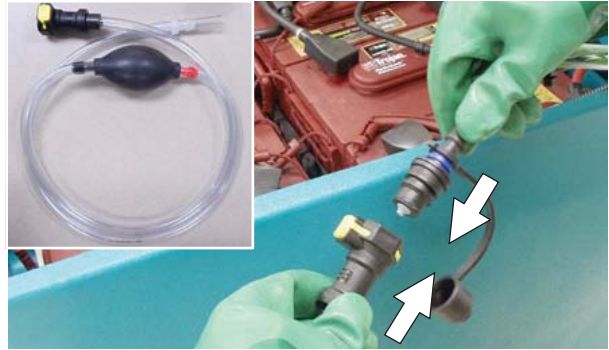

4. Submerge the other end of the hand pump hose into a bottle of distilled water.



5. Squeeze the bulb on the hand pump hose until firm. The level indicators will turn white when full.

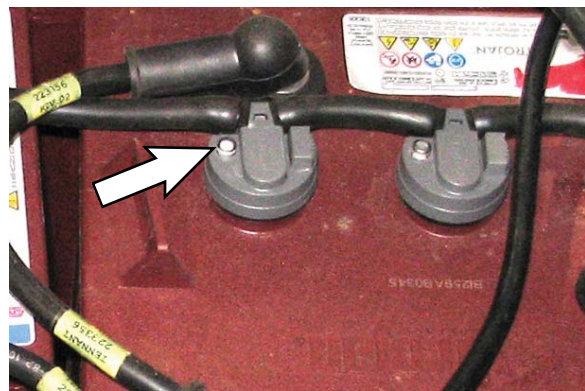

6. After adding water, reinstall the dust cap onto the battery fill hose and store the hand pump hose inside the battery compartment for future use.

SMART-FILL ABW (AUTOMATIC BATTERY WATERING) SYSTEM

FOR SAFETY: Before leaving or servicing machine, stop on level surface, turn off machine, and remove key.

The *Smart-Fill* ABW system is designed to automatically refill the batteries after the machine reaches a limited number of charge cycles. Do not remove battery caps to manually add water to the batteries.

Check the *Smart-Fill* ABW system for leaks, loose hose connections, and for damage or wear after every 100 hours. Replace if damaged.

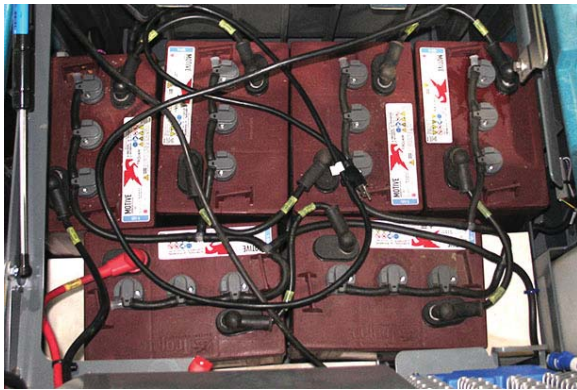

The ABW tank is located behind the shroud on the right side of the machine. Press the release and tilt the shroud, or lift the shroud, from the machine to access the automatic watering tank.



Periodically check the water level in the ABW tank. Add distilled water when low.

FOR SAFETY: When servicing machine, only use distilled water when filling the automatic battery watering tank.



The automatic battery watering indicator will also alert user to add distilled water when tank is empty. See SMART-FILL ABW (AUTOMATIC BATTERY WATERING) INDICATOR.

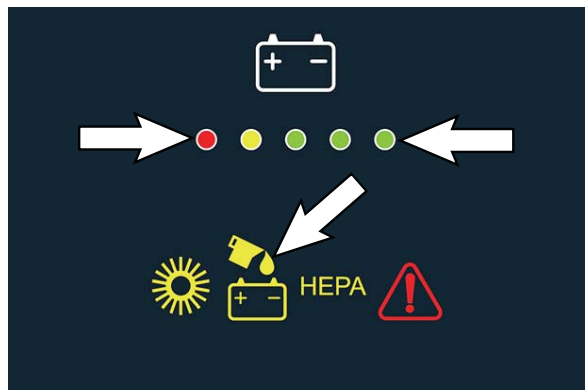

BATTERY COMPARTMENT DRAIN VALVE

Use the battery compartment drain valve to drain liquid from the battery compartment. Check the battery compartment for liquid weekly and drain if there is liquid in the battery compartment.

FOR SAFETY: When servicing machine, always follow site safety rules when disposing battery compartment liquid.

1. Position the machine over an area where the battery compartment can be safely drained, turn off the machine, and remove the key.

FOR SAFETY: Before leaving or servicing machine, stop on level surface, turn off machine, and remove key.

1. Release the main sweeping brush compartment access door and open the door to access the battery compartment drain valve located in the main sweep brush compartment
2. Open the battery compartment drain valve and allow the liquid to drain from the battery compartment.

FOR SAFETY: When servicing machine, wear personal protection equipment as needed. Avoid contact with battery acid.



3. Close the battery compartment drain valve after all liquid has drained from the battery compartment.

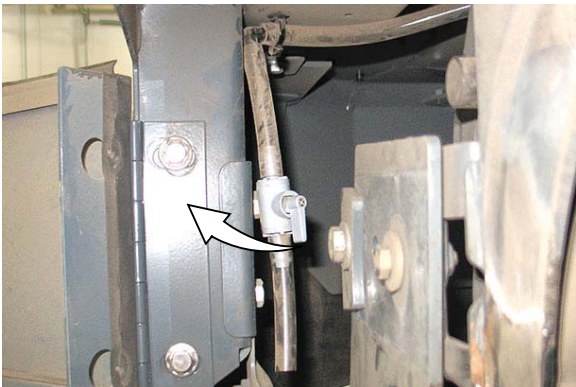

CIRCUIT BREAKERS, FUSES, AND RELAYS

CIRCUIT BREAKERS

Circuit breakers are resettable electrical circuit protection devices designed to stop the flow of current in the event of a circuit overload. Once a circuit breaker is tripped, reset it manually by pressing the reset button after the breaker has cooled down.

Circuit breakers 1 through 11 are located in the electrical compartment behind the operator seat. Remove the electrical compartment cover to access the circuit breakers.



Circuit breakers 12 through 19 are located behind the steering shroud access panel.



If the overload that caused the circuit breaker to trip is still present, the circuit breaker will continue to stop current flow until the problem is corrected.

The chart below shows the circuit breakers and the electrical components they protect.

Circuit Breaker	Rating	Circuit Protected
CB1	40A	Main control board
CB2	40A	Main sweep motor
CB3	30A	Vacuum fan motor
CB4	30A	HEPA vacuum fan motor
CB5	15A	Filter shaker
CB6	2.5A	User interface/ignition
CB7	2.5A	Key switch
CB8	2.5A	Headlight/taillight/strobe light switch (option)
CB9	25A	Vacuum wand fan motor
CB10	2.5A	Smart-Fill ABW (Automatic Battery Watering) (option)
CB11	-	Not Used
CB12	15A	Left side brush motor
CB13	15A	Right side brush motor
CB14	2.5A	Front horn and reverse selected
CB15	2.5A	Vacuum wand switch (option)
CB16	2.5A	Blue lights (option)
CB17	-	Not Used
CB18	-	Not Used
CB19	-	Not Used

MAINTENANCE

FUSES

Fuses are one-time protection devices designed to stop the flow of current in the event of a circuit overload. Never substitute higher value fuses than specified.

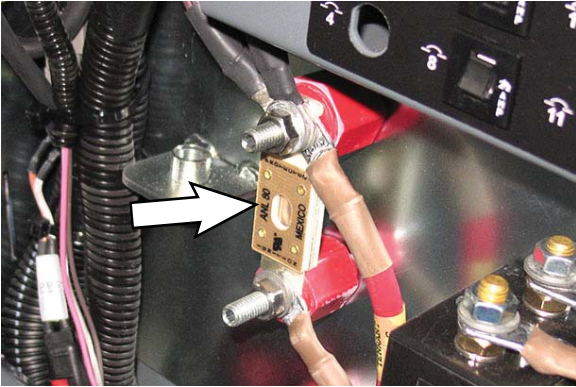

The fuses are located in the control box behind the circuit breaker panel or in-line on harnesses and cables.

Fuse	Rating	Circuit Protected
Fuse-1	80A	Propel system

RELAYS

Relays are electrical switches that open and close under the control of another electrical circuit. Relays are able to control an output circuit of higher power than the input circuit. The main contactor relay (M1) is located in the electrical compartment behind the operator seat. The charger bypass relay (M2) is located behind the circuit breaker panel in the electrical compartment behind the operator seat. The vacuum wand relay (M3) is located in the vacuum wand compartment.

Refer to the table below for the relays and circuits controlled.

Relay	Rating	Circuit Controlled
M1	36 VDC, 200 A	Main Contactor
M2	36 VDC, 25 A	Charger Bypass
M3	36 VDC, 25 A	Vacuum Wand (option)

ELECTRIC MOTORS

Inspect the carbon brushes on the various electric motors. Refer to the table below for carbon brush inspection intervals.

Carbon Brush Inspection	Hours
Vacuum fan motor	1750
HEPA vacuum fan motor (Option)	500
Vacuum wand fan motor (Option)	500

HEPA (HIGH EFFICIENCY PARTICULATE ARRESTANCE) FILTRATION SYSTEM (OPTION)

The HEPA (High Efficiency Particulate Arrestance) filtration system is a dry sweeping system consisting of dry dust control and a HEPA filter. The filters, skirts and seals in each of these areas are critical in the performance of the HEPA system.

The optional HEPA filtration system helps clean in fine dust environments.

NOTE: While cleaning or performing any type of maintenance on HEPA filter systems, refer to company or local regulations regarding safety requirements.

HOPPER

Inspect and clean the hopper daily.

CLEANING THE LOW DUMP HOPPER

1. Turn the *key switch* OFF.

FOR SAFETY: Before leaving or servicing machine, stop on level surface, turn off machine, and remove key.

2. Remove the hopper from the machine. See *EMPTYING THE HOPPER (LOW DUMP MACHINES)* for instructions for removing the hopper from the machine.



3. Clean any debris from hopper.
4. HEPA Machines: Use a garden hose to clean the hopper.

5. Machines equipped with optional removable hopper bins only: Lift the bins from the hopper and empty and rinse the bins. Reinstall the bins into the hopper.



6. Reinstall the hopper into the machine.
7. Allow hopper to dry before using the machine.

CLEANING THE HIGH DUMP HOPPER

1. Turn on the machine, raise the hopper until the *hopper roll out switch* lights are illuminated, completely roll out the hopper, and turn off the machine.



2. Clean any debris from hopper.
3. HEPA Machines: Use a garden hose to clean the hopper.
4. Turn on the machine, roll in the hopper, lower the hopper, and turn off the machine.
5. Allow hopper to dry before using the machine.

HOPPER DUST FILTER

FOR SAFETY: Before leaving or servicing machine, stop on level surface, turn off machine, and remove key.

REMOVING / REPLACING THE HOPPER DUST FILTER

Shake the dust filter at the end of every shift and before removing the filter from the machine. Inspect and clean the filter after every 100 hours of operation. Replace damaged dust filters.

NOTE: Clean the filter more often if used in extremely dusty conditions.

1. Loosen each hopper filter compartment retainer located on both sides of the filter compartment.



2. Lift the hopper filter compartment until the hopper filter compartment prop arms secure the hopper filter compartment open.

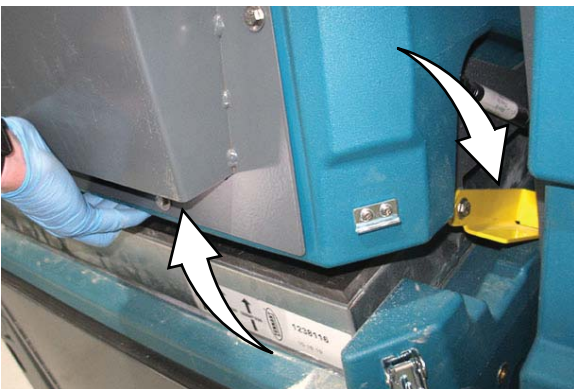

NOTE: Ensure the hopper filter compartment prop arm is fully engaged before removing the filter from the machine.

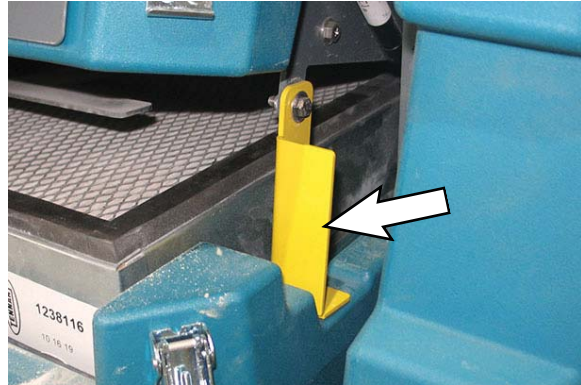

3. Remove the filter from the hopper filter compartment



4. Clean or discard the dust filter element. Refer to *CLEANING THE DUST FILTER*.
5. Machines with the *FiberShield* lint screen option only: Remove the lint screen from the hopper filter compartment and clean dust and debris from the lint screen. Reinstall the lint screen.



6. Reinstall the dust filter.
7. Disengage the hopper filter compartment prop arms, lower the hopper filter compartment, and secure the hopper filter compartment closed.

**CLEANING THE HOPPER DUST FILTER
(MACHINES EQUIPPED WITH STANDARD
FILTRATION SYSTEM)**

Use one of the following methods to clean the dust filter:

SHAKING-Press the *filter shaker switch*.

TAPPING-Tap the filter gently on a flat surface.
Do not damage the edges of the filter. The filter will not seal properly if the edges of the filter are damaged.



AIR-Always wear eye protection when using compressed air. Blow air through the center of the filter and out toward the exterior. Never use more than 550 kPa (80 psi) of air pressure with a nozzle no smaller than 3 mm (0.13 in) and never hold the nozzle closer than 50 mm (2 in) to the filter.



**CLEANING THE HOPPER DUST FILTER
(MACHINES EQUIPPED WITH HEPA
FILTRATION SYSTEM ONLY)**

NOTE: Do Not clean the HEPA filter when it becomes clogged with debris. The HEPA cannot be cleaned and must be replaced when damaged or clogged. The following cleaning methods can only be used to clean the hopper dust filter.

Use one of the following methods to clean the dust filter:

SHAKING-Press the *filter shaker switch*.

TAPPING-Tap the filter gently on a flat surface.
Do not damage the edges of the filter. The filter will not seal properly if the edges of the filter are damaged.



Do Not use air to clean the dust filter.



MAINTENANCE

Inspect the dust filter seals for proper seal and damage after every 100 hours of operation. Dust build up on the seal surfaces means dust is getting past the dust filter, significantly reducing the filter life.

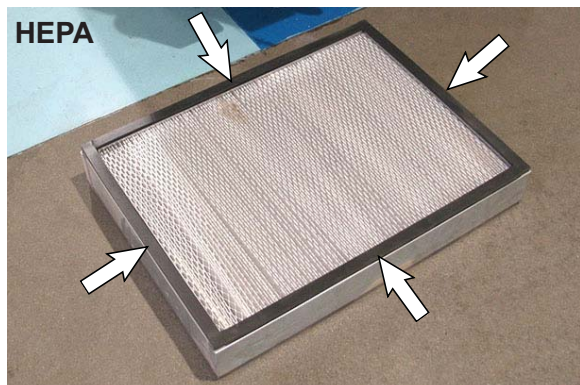

ADJUSTING THE HOPPER FILTER COVER LATCHES

Adjust the filter cover latch lengths if there is poor vacuum performance.

1. Remove the hopper dust filter from the machine.
2. Check the latch length. The latch should begin to pull the latch keeper at approximately 0 and 45 degrees from horizontal.



3. Leave the latch hook still attached to the latch keeper, and turn the jam nut to shorten the latch length.



INSPECTING / CLEANING THE PERMA-FILTER

Inspect and clean the Perma-Filter after every 100 hours of operation.

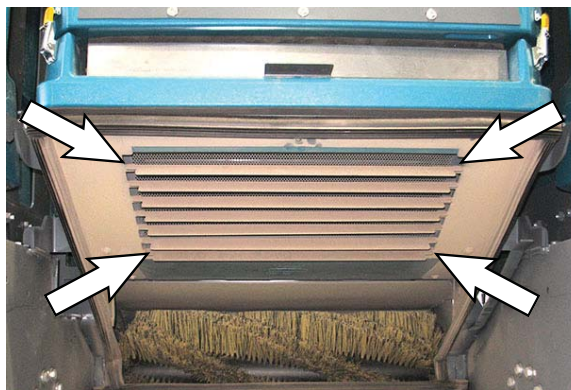

THERMO-SENTRY

The Thermo-Sentry, located inside the hopper, senses the temperature of the air pulled up from the hopper. If there is a fire in the hopper, the Thermo-Sentry stops the vacuum fan and cuts off the air flow. There is also an audible alarm when the Thermo-Sentry is activated. The Thermo-Sentry automatically resets after cooling down.

REPLACING THE HEPA FILTER

Replace the HEPA filter when the HEPA light is illuminated. When the light is illuminated, check the system for blockages that may be restricting the flow to the HEPA filter.

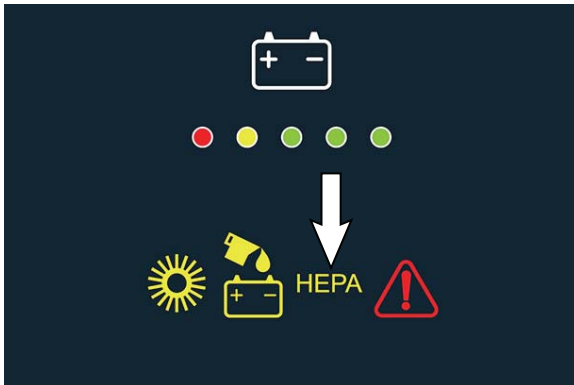

FOR SAFETY: Before leaving or servicing machine, stop on level surface, turn off machine, and remove key.

1. Remove the hardware securing the HEPA tray assembly to the hopper.



2. Remove the HEPA tray assembly from the hopper.



3. Remove the hardware securing the HEPA filter to the HEPA tray and remove the HEPA filter from the tray.

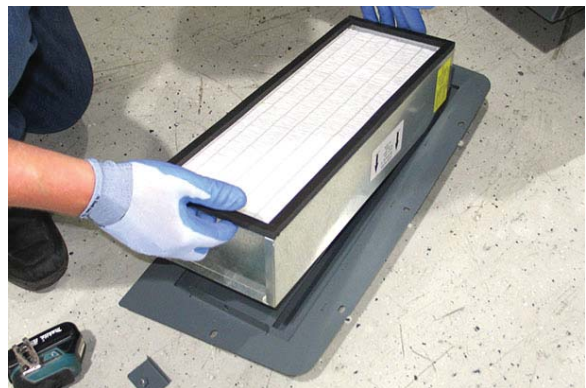

NOTE: Do Not touch or damage the new HEPA filter media when installing the HEPA filter onto the HEPA tray.

4. Orient the new HEPA filter so the label is located at the top of the HEPA tray and the arrows on the label point out the direction of the airflow.



MAINTENANCE

- Slide the HEPA filter into the HEPA filter tray. Be sure the edge of the HEPA filter is secure under the tray retainer.

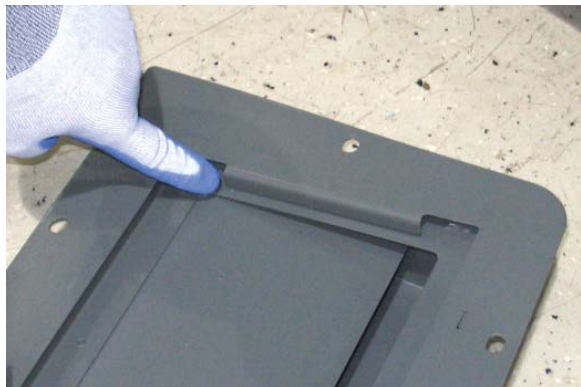

- Reinstall and tighten the hardware to secure the other end of the HEPA filter into the HEPA filter tray.

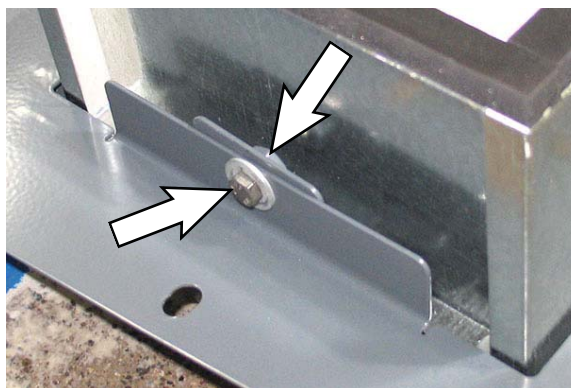

- Inspect the HEPA fan vacuum fan tray seal for damage and evidence of leaks (excessive dust deposited on seal surfaces). Replace the seal if it is damaged or there are leaks.

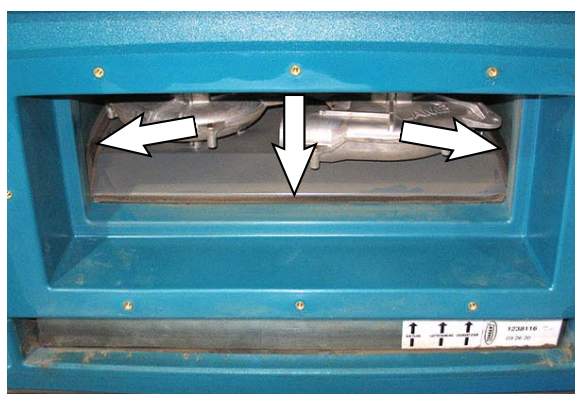

- Reinstall the HEPA filter tray assembly into the machine.



MAIN SWEEP BRUSH

Check the brush daily for wear. Lower the brush and observe the *brush wear site* on the main sweep brush idler arm. If the site is at the bottom of the brush wear label (red portion of label is visible in the site), replace the main sweep brush.

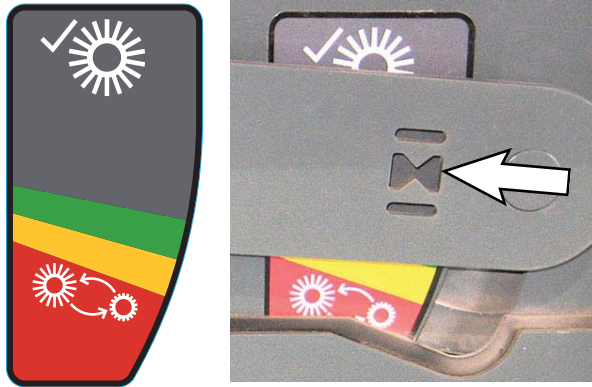

Observe the brush for damage. Remove any string or wire tangled on the main brush, main brush drive hub, or main brush idler hub.



Rotate the brush end-for-end after every 50 hours of operation, for maximum brush life and best sweeping performance. Refer to REPLACING OR ROTATING THE MAIN BRUSH.

Replace the brushes when they no longer clean effectively or when brush worn icon is illuminated to alert that the brush needs to be changed.



REPLACING THE MAIN SWEEPING BRUSH

1. Raise the sweeping main brush and turn off the machine.

FOR SAFETY: Before leaving or servicing machine, stop on level surface, turn off machine, and remove key.

2. Release the main sweeping brush compartment access door and open the access door.



3. Remove the knobs securing the idler arm assembly to the main sweep assembly.



MAINTENANCE

4. Remove the idler arm assembly from the main brush assembly.



5. Pull the brush from the main sweep compartment.



6. Put the new or rotated end-for-end main brush on the floor next to the main sweep compartment.
7. Slide the main brush onto the drive plug. Rotate the brush until it engages the drive plug, and push it completely onto the plug.



8. Reinstall the idler arm assembly onto the main sweep assembly. Be sure to keep the idler arm above the brush compartment skirt when installing the idler arm assembly onto the main sweep assembly.



9. Reinstall the hardware to secure the idler arm to the main sweep assembly. Hand tighten the hardware.
10. Close and secure the main sweep brush compartment access door.

CHECKING THE MAIN SWEEP BRUSH PATTERN

1. Apply chalk, or a similar marking material, to a smooth and level section of the floor.

NOTE: If chalk or other material is not available, allow the brush to spin on the floor for two minutes. A polish mark will remain on the floor.

2. Turn the key switch ON.
3. Position the main brush over the chalked area.
4. Press and hold the *1-Step button* for 5 seconds. The machine will go into the brush pattern check mode. The LED indicator will continue flashing while the brush pattern check is in progress.

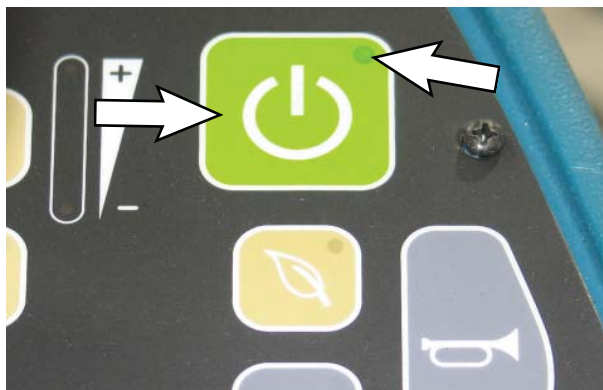

NOTE: The pattern check sequence will be canceled if the 1-Step button is pressed at any time during the brush pattern check sequence.

5. The main brush motor will turn on and the actuator will partially lower to check the motor operating currents. The main brush will then continue to lower until the motor reaches the selected down force target current or until the actuator is fully extended.

NOTE: If the monitored current of the main brush/ selected side brush(es) is outside the correct range, the brush pattern check sequence will be canceled and a main sweep system fault will be displayed.

6. The pattern check will run for approximately 10 seconds at which point the main brush will raise and the brush motor will turn off. The *1-Step* LED indicator will stop flashing when the brush pattern check is completed.

7. Drive the machine off the test area.
8. Observe the width of the brush pattern. The proper brush pattern width is 50 to 89 mm (2 to 3.5 in).

The brush taper is factory set and should not need adjustment unless parts of the brush system have been replaced.

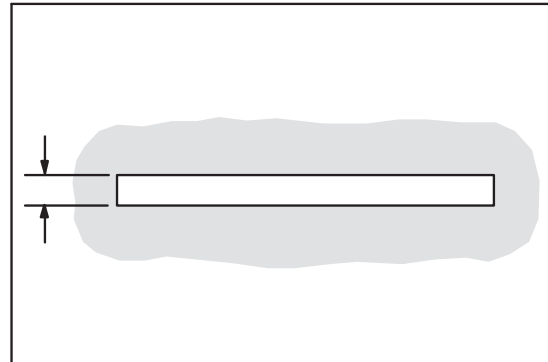

00582

If the main brush pattern is tapered, more than 15 mm (0.5 in) on one end than the other, adjust the taper. Refer to ADJUSTING THE MAIN SWEEP BRUSH PATTERN:

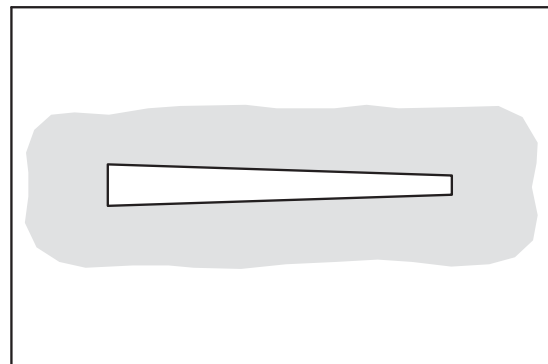

00601

ADJUSTING THE MAIN SWEEP BRUSH PATTERN

1. Loosen the brush shaft bearing bracket mounting hardware and the idler arm knob.

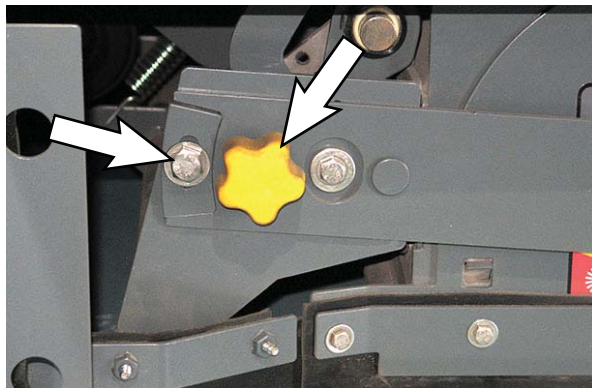

2. Turn the key switch ON.
3. Position the main brush over the chalked area.
4. Press and hold the *1-Step button* for 5 seconds. The machine will go into the brush pattern check mode. The LED indicator will continue flashing while the brush pattern check is in progress.



NOTE: The pattern check sequence will be canceled if the *1-Step button* is pressed at any time during the brush pattern check sequence.

5. The main brush motor will turn on and the actuator will partially lower to check the motor operating currents. The main brush will then continue to lower until the motor reaches the selected down force target current or until the actuator is fully extended.
6. The pattern check will run for approximately 10 seconds at which point the main brush will raise and the brush motor will turn off. Turn the key switch OFF before the brush raises.
7. Tighten the brush shaft bearing bracket mounting hardware and the idler arm knob.
8. Recheck the main brush pattern. See CHECKING THE MAIN SWEEP BRUSH PATTERN. Adjust the main brush taper as necessary.

SIDE BRUSH(ES)

Check the side brush(es) daily for wear or damage. Remove any tangled string or wire from the side brush(es) or side brush drive hubs.

REPLACING THE SIDE BRUSH(ES)

Replace the brushes when they no longer clean effectively.

1. Raise the side brush(es) and turn off the machine.

FOR SAFETY: Before leaving or servicing machine, stop on level surface, turn off machine, and remove key.

2. Reach into the center of the brush and remove the cotter pin and washer holding the brush and the retainer to the hub.



3. Remove the side brush and retainer from under the side brush assembly.



4. Place the side brush underneath the side brush assembly and align the channel in the retainer with the retainer pin in the side brush hub.



5. Lift the side brush, retainer, and washer up onto the side brush hub and reinstall the cotter pin into the hub.

CHECKING THE SIDE BRUSH PATTERN(S)

Check the side brush pattern after every 50 hours of operation or whenever the brush(es) is/are replaced.

1. Turn the key switch ON.
2. Press the side brush button(s) to activate the side brush(es).
3. Press and hold the *1-Step button* for 5 seconds. The LED indicator will begin flashing and continue flashing until the brush pattern check is complete.

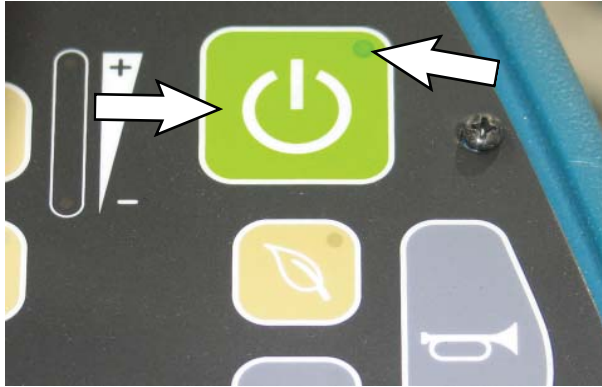

NOTE: The pattern check sequence will be canceled if the 1-Step button is pressed at any time during the brush pattern check sequence.

4. The side brush motor(s) will turn on and the actuators will partially lower to check the motor operating currents.

NOTE: If the monitored current of the side brush motor(s) is outside the correct range, the brush pattern check sequence will be canceled and a side sweep system fault will be displayed.

5. The side brush(es) will continue to lower until the actuator(s) is/are fully extended.

6. Observe the side brush pattern(s).

The right side brush bristles should touch the floor between 10 o'clock and 3 o'clock and the left side brush bristles should touch the floor between 9 o'clock and 2 o'clock when the brushes are in motion.

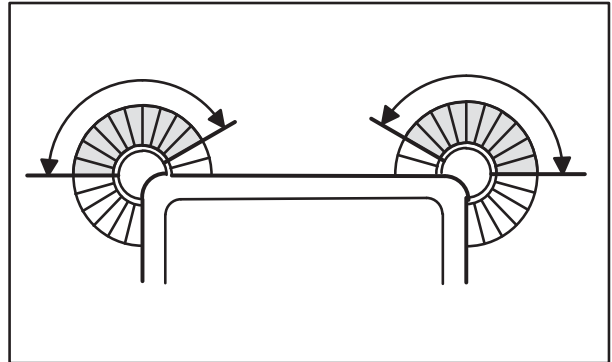

350327

7. Adjust the side brush pattern(s) as necessary. See **ADJUSTING THE SIDE BRUSH PATTERN(S)**.

ADJUSTING THE SIDE BRUSH PATTERN(S)

The side brush pattern(s) should be adjusted whenever the side brush(es) is/are replaced or when it is determined that the brush patterns need adjustment following the patterns being checked.

1. Raise the side brush(es) and turn off the machine.

FOR SAFETY: Before leaving or servicing machine, stop on level surface, turn off machine, and remove key.

2. Loosen the top star knob approximately a 1/2 turn.

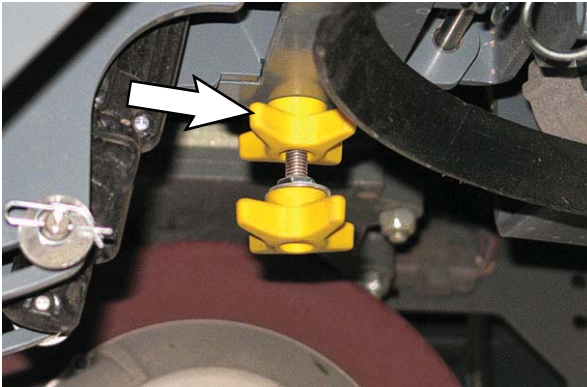

3. Turn the bottom star knob counterclockwise to increase the brush pattern.

Turn the bottom star knob clockwise to decrease the brush pattern.

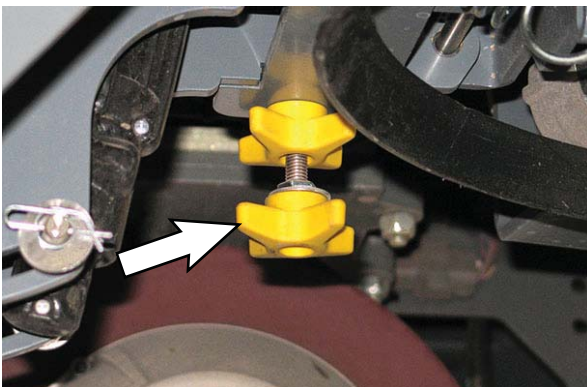

4. Tighten the upper star knob to secure the side brush pattern adjustment.
5. Recheck the side brush pattern(s). See CHECKING THE SIDE BRUSH PATTERN(S). Adjust the side brush patterns as necessary.

SKIRTS AND SEALS

FOR SAFETY: Before leaving or servicing machine, stop on level surface, turn off machine, and remove key.

LARGE DEBRIS TRAP SKIRT

The large debris trap skirt is raised and lowered by the large debris trap pedal, allowing larger debris to be trapped and swept up into the hopper.

Check the skirt for damage and wear after every 100 hours of operation. Check the skirt length after every 100 hours of operation. The skirt should be long enough to barely touch floor, but not so long that it becomes caught in the main brush.

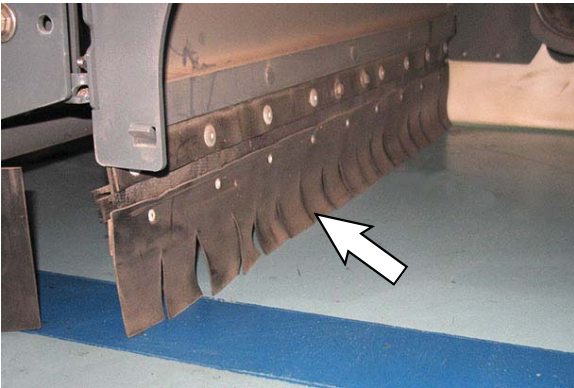

To change the large debris trap skirt:

1. Release the main sweeping brush compartment access door and open the door to access the main sweep brush compartment.
2. Remove the cotter pin/clevis pin securing the large debris trap skirt to the sweep head.

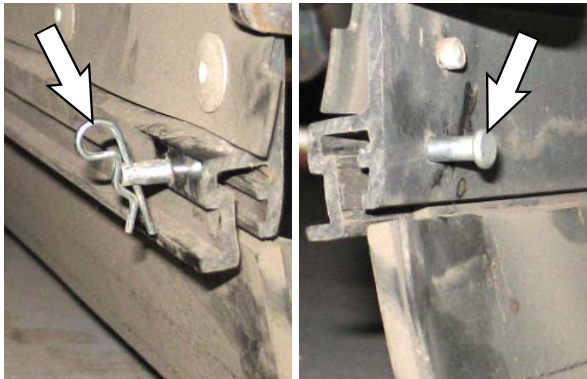

3. Pull the large debris trap skirt from the sweep head.

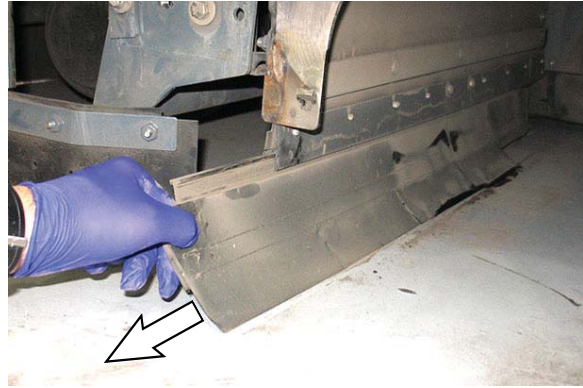

4. Install the new large debris trap skirt onto the sweep head.
5. Reinstall the cotter pin/clevis pin to secure the large debris trap skirt to the sweep head.

SIDE SKIRTS

The side skirts are located on both sides of the machine in front of the main brush compartment. The side skirts should slightly touch a flat floor surface.

Check the skirts for damage, wear and adjustment daily.



SIDE RECIRCULATION SKIRTS

The side recirculation skirts are located on both sides of the main brush compartment. The side recirculation skirts should slightly touch a flat floor surface.

Check the skirts for damage, wear and adjustment daily.

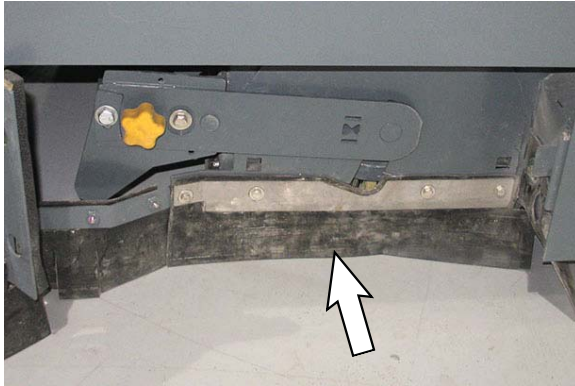

REAR RECIRCULATION SKIRT

The rear recirculation skirt is located on the bottom rear of the main brush compartment, directly behind the main sweep brush. The recirculation skirt should not touch the main sweep brush when the brush is sweeping.

Check the skirt for damage, wear and adjustment daily.

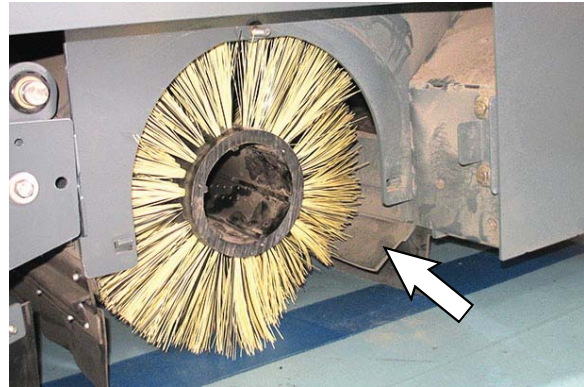

REAR SKIRT

The rear skirt is located on the bottom rear of the main brush compartment. The vertical skirt should slightly touch a flat floor surface.

Check the skirt for damage, wear and adjustment daily.

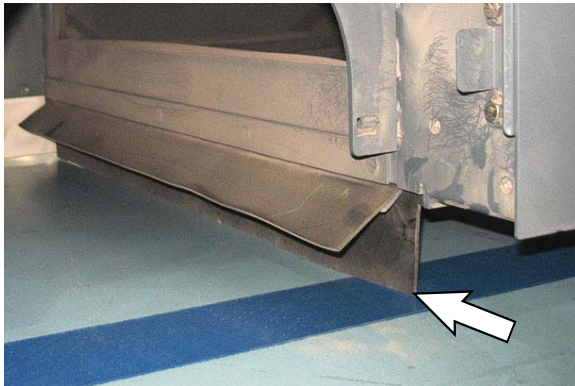

SIDE BRUSH DUST CONTROL SKIRTS (OPTION)

The single side brush dust control skirts and dual side brush dust control skirts wrap around the entire side brush assembly for machines equipped with the single side brush and around both side brush assemblies for machines equipped with dual side brushes. The side skirts should slightly touch a flat floor surface.

Check the skirts for wear and damage daily.

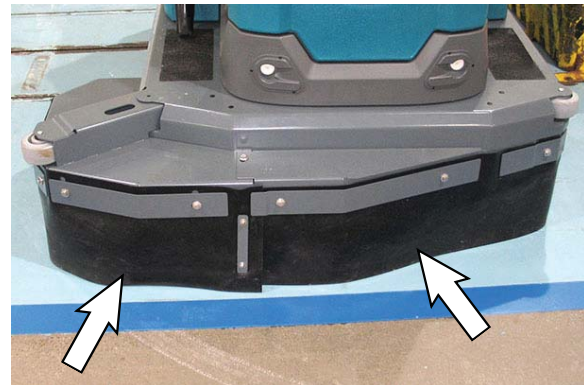

MAINTENANCE

HOPPER SEALS

The hopper seals are located around the edge of the opening between the main brush and the hopper. The hopper rests against the seals when the hopper is in the closed position.

Check the seals for wear or damage after every 100 hours of operation.

Machines equipped with high dump:



WARNING: Raised hopper may fall. Engage hopper support bar.

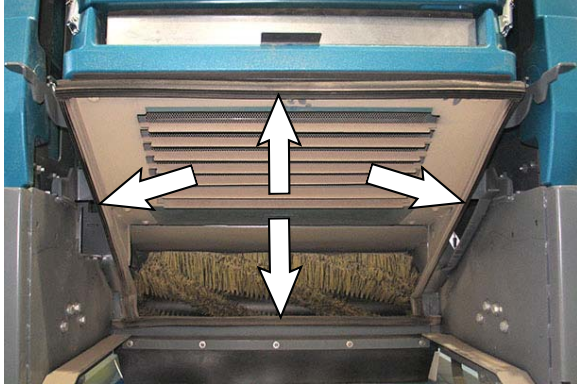

VACUUM SEAL

The vacuum seal is located on top the debris hopper and seals with the hopper filter when the hopper is in the closed position.

Check the seal for wear or damage after every 100 hours of operation.

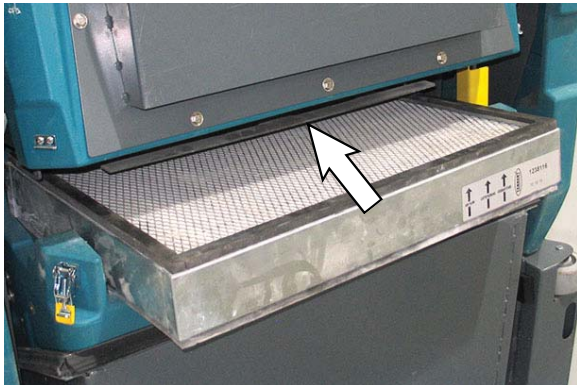

SWEEP COMPARTMENT HEPA SIDE SKIRTS (MACHINES EQUIPPED WITH HEPA FILTRATION SYSTEM OPTION ONLY)

The sweep compartment HEPA side skirts with machines equipped with HEPA filtration are located on both sides of the main brush compartment. The sweep compartment HEPA side skirts should slightly touch a flat floor surface.

Check the skirts for damage, wear and adjustment daily.



BRUSH COMPARTMENT SKIRTS (MACHINES EQUIPPED WITH HEPA FILTRATION SYSTEM OPTION ONLY)

The brush compartment skirts with machines equipped with HEPA are located on both sides of the machine at the rear of the main brush compartment.

Check the skirts for wear and damage daily.



MAIN BRUSH DOOR SEALS (MACHINES EQUIPPED WITH HEPA FILTRATION SYSTEM OPTION ONLY)

Main brush door seals for machines equipped with HEPA filtration are located on the top and rear of both main brush doors.

Check the seals for wear or damage daily.

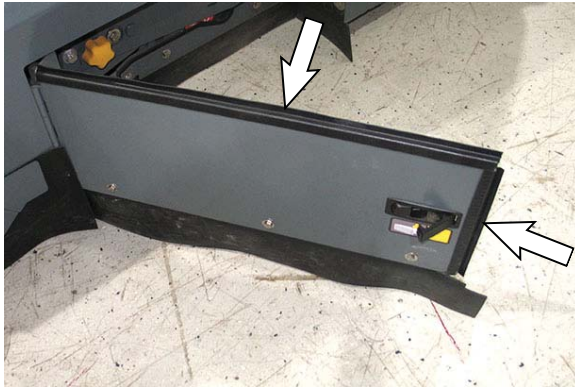

BELTS

MAIN BRUSH DRIVE BELT

FOR SAFETY: Before leaving or servicing machine, stop on level surface, turn off machine, and remove key.

The main brush drive belt is located on the main sweep brush head. Check the belt for damage and wear after every 100 hours of operation.

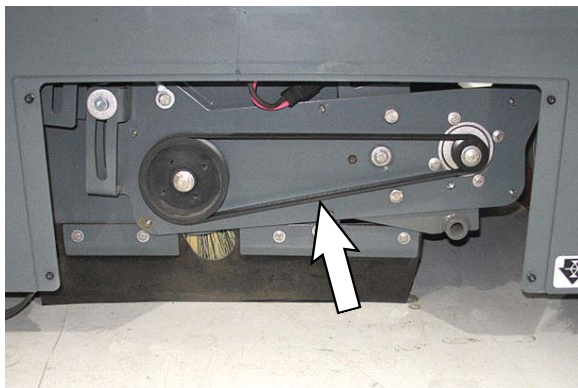

TIRES

FOR SAFETY: Before leaving or servicing machine, stop on level surface, turn off machine, and remove key.

The machine has three solid rubber tires: one in front, and two in the rear of the machine. Check tires for damage and wear after every 500 hours of operation.

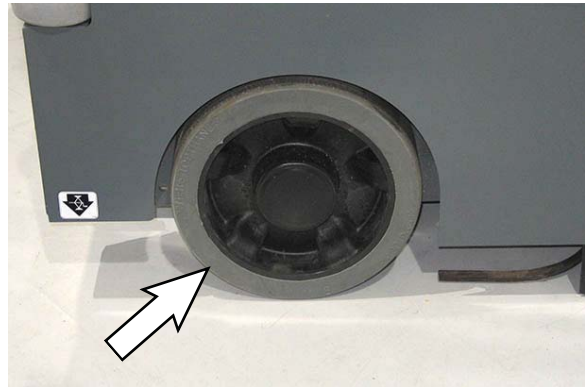

VACUUM WAND MAINTENANCE (OPTION)

VACUUM WAND FAN

FOR SAFETY: Before leaving or servicing machine, stop on level surface, turn off machine, and remove key.

Check the vacuum wand fan for damage after every 50 hours of operation.

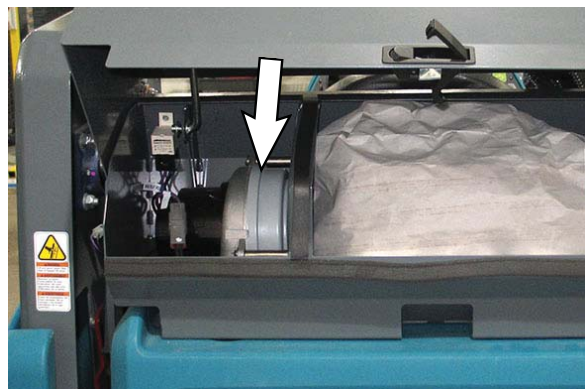

MAINTENANCE

REPLACING THE VACUUM WAND BAG

Check the vacuum wand bag after every 50 hours of operation. Replace the vacuum wand bag when the wand begins to lose power, the bag is full, or if the bag is torn or damaged.

FOR SAFETY: Before leaving or servicing machine, stop on level surface, turn off machine, and remove key.

1. Press the latch release to allow the vacuum wand housing cover to be opened.



2. Lift the vacuum wand housing cover open and use the prop rod to secure the cover open.



3. Remove the vacuum wand bag from the vacuum wand compartment.



4. Install the new vacuum wand bag into the vacuum wand compartment. Be sure the bag is completely installed onto the vacuum tube.
5. Release the vacuum wand housing cover support and close and secure the vacuum wand compartment cover.



PUSHING, TOWING, AND TRANSPORTING THE MACHINE

PUSHING OR TOWING THE MACHINE

FOR SAFETY: When servicing the machine, do not push or tow the machine without an operator in the seat controlling the machine.

If the machine becomes disabled, it can be pushed from the front or rear, but it can only be towed from the front.

The parking brake must be disabled before towing or pushing the machine. To disable the brake, insert the tip of a small screw driver between the electronic brake lever and the hub. The machine can move freely when the parking brake is disabled.



Only push or tow the machine for a very short distance and do not exceed 3.2 kp/h (2 mph). It is NOT intended to be pushed or towed for a long distance or at a high speed.

ATTENTION! Do not push or tow machine for a long distance or damage may occur to the propelling system.

Immediately after pushing the machine, remove the screw driver from between the electronic brake lever and the hub. NEVER operate the machine with the parking brake disabled.

FOR SAFETY: Do not operate machine with brake disabled.

TRANSPORTING THE MACHINE

FOR SAFETY: When transporting Lithium- ion Battery Model, contact Tennant or your local regulatory authorities for proper transporting instructions.

1. Raise the sweep head.
2. Remove the hopper (Low Dump) or raise the hopper enough (High Dump) to clear the ground before loading. The machine can be loaded onto a ramp up to 21.3%.
3. Park the truck or trailer on a level surface.
4. Position the back end of the machine at the loading edge of the truck or trailer.

NOTE: The machine ability to climb a ramp is affected by tire wear, ramp surface, weather conditions, and other factors. Trailering should be performed by personnel trained on how to safely load a machine.

5. Drive the machine onto the trailer or truck. Position the machine so the weight of the machine is safely distributed and can be safely strapped down to the trailer or truck.



6. Turn the key switch OFF.
7. Place a block behind each wheel to prevent the machine from rolling.

NOTE: It may be necessary to install tie-down brackets to the floor of the trailer or truck.

FOR SAFETY: When loading/unloading machine onto/off truck or trailer, use tie-down straps to secure machine.

MAINTENANCE

8. Connect the tie-down straps to the holes in the rear of the frame, directly below the bumper wheels located on both sides of the machine and secure the tie-downs to the trailer or truck to prevent the machine from moving.



9. Connect the tie-down straps to the front of the frame of the machine, in the recessed area located on both sides of the machine directly behind each front bumper wheel and secure the tie-downs to the trailer or truck to prevent the machine from moving.



If machine is equipped with the optional dust control skirts, connect the tie down straps to the holes in the bumper wheel brackets located on each side of the machine to secure the machine to the truck or trailer.

NOTE: Ensure the straps are not placing pressure on the rear of the skirt mount when the tie down straps are tightened,



10. Ensure all tie-down straps are fully tightened and machine is completely secure on the trailer or truck.

MACHINE JACKING

FOR SAFETY: Before leaving or servicing machine, stop on level surface, turn off machine, and remove key.

Empty the hopper before jacking the machine.

Jacking point locations at the front of all machines.

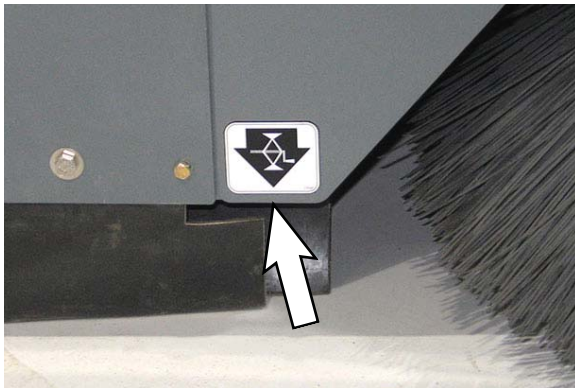
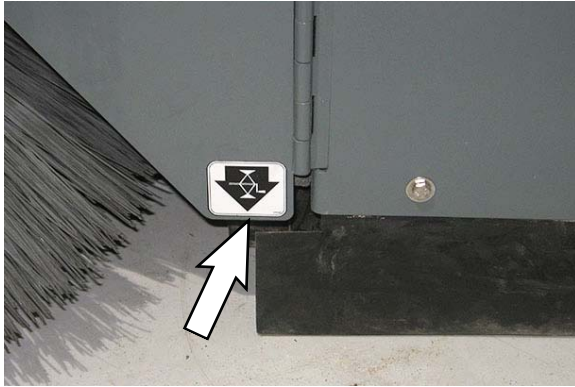

Jacking point locations at the rear of all machines.

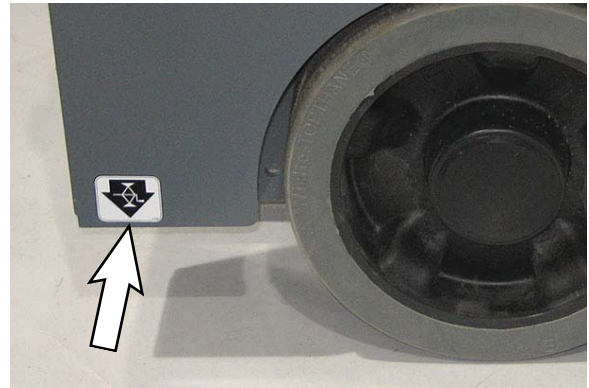
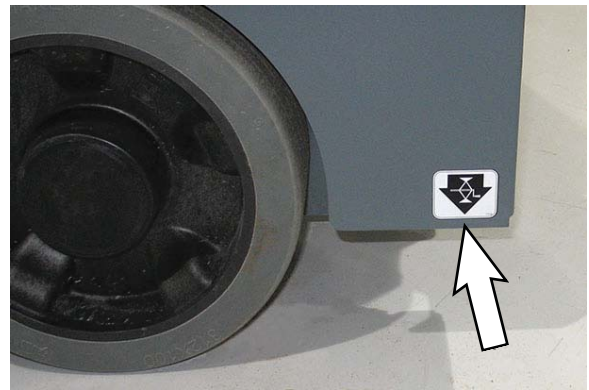

FOR SAFETY: When servicing machine, block machine tires before jacking machine up. Use a hoist or jack that will support the weight of the machine. Jack machine up at designated locations only. Support machine with jack stands.

STORAGE INFORMATION

The following steps should be taken when storing the machine for extended periods of time.

ATTENTION: Do not expose machine to rain, store indoors.

1. Park the machine in a cool, dry area. Do not expose the machine to rain or snow. Store indoors.
2. Charge the batteries before storing machine to prolong the life of the batteries. Recharge lead-acid batteries once a month. Recharge lithium-ion battery pack once a year.
3. Disconnect batteries before storing.
4. Store the machine in a dry area with the sweep head in the raised position.

NOTE: To prevent potential machine damage store machine in a rodent and insect free environment.

SPECIFICATIONS**SPECIFICATIONS****GENERAL MACHINE DIMENSIONS/
CAPACITIES**

Item	Dimension / Capacity
Length	1815 mm (71 in)
Width (Body)	1168 mm (46 in)
Width (Body with optional left side brush)	1168 mm (46 in)
Wheel base	1206 mm (47.5 in)
Height (Without overhead guard)	1500 mm (59 in)
Height (With overhead guard)	2095 mm (82.5 in)
Height (With high dump)	1570 mm (61.8 in)
Track	1030 mm (40.5 in)
Main brush length (Cylindrical)	810 mm (32 in)
Side brush diameter (Disk)	510 mm (20 in)
Sweeping path width (Single side brush)	1170 mm (46 in)
Sweeping path width (Dual side brushes)	1520 mm (60 in)
Hopper volume capacity	150 L (5.3 ft ³)
Hopper weight capacity (High Dump)	159 Kg (350 lbs)
Hopper weight capacity (Low Dump)	91 Kg (200 lbs)
Hopper maximum dump height (High Dump)	1572 mm (61.9 in)
Hopper minimum ceiling dump height (High Dump)	2220 mm (87.4 in)
Dust filter area (Standard)	9 m ² (97 ft ²)
Dust filter area (HEPA)	4.6 m ² (50 ft ²)
Weight no batteries (High Dump)	793 Kg (1748 lbs)
Weight no batteries (Low Dump)	698 Kg (1538 lbs)
Weight high dump (with standard batteries)	975 Kg (2150 lbs)
Weight low dump (with standard batteries)	880 Kg (1940 lbs)
GVWR (High Dump)	1406 Kg (3100 lbs)
GVWR (Low Dump)	1243 Kg (2740 lbs)
Protection Grade	IPX5

Values determined as per IEC 60335-2-72	Measure
Sound pressure level LpA	67 dB
Sound pressure uncertainty KpA	3 dB
Sound power level LWA + Uncertainty KWA	91 dB + 2.98 dB
Vibration - Hand-arm	<2.5 m/s ²
Vibration - Whole body	<0.5 m/s ²

GENERAL MACHINE PERFORMANCE

Item	Measure
Aisle turnaround width (less side brush)	2140 mm (84 in)
Travel Speed (Forward)	8.8 Km/h (5.5 mph)
Travel Speed while sweeping (Forward)	8.8 Km/h (5.5 mph)
Travel Speed lifted hopper (Forward)	2.4 Km/h (1.5 mph)
Travel Speed (Reverse)	4.8 Km/h (3 mph)
Maximum ramp incline for loading - Empty	21.3% / 12°
Maximum ramp incline for sweeping	14.1% / 8°
Maximum ramp incline for transporting (GVWR)	21.3% / 12°
Maximum ambient temperature for machine operation	43° C (110° F)
Minimum temperature for operating machine sweeping functions	0° C (32° F)

POWER TYPE

Type	Quantity	Volts	Ah Rating	Weight
Lead-acid Batteries (Max. battery dimensions): 28.8 in / 731 mm W x 19.9 in / 506 mm L x 15.6 in / 395 mm H	6	36	240 @ 20 hr rate	30 kg (67 lb)
	6	36	360 @ 20 hr rate	44 kg (98 lb)
Lithium-ion Battery	2 pack	36	110 / 4.1 kWh	51 Kg (112 lb)
	4 pack	36	221 / 8.2 kWh	83 Kg (183 lb)
	6 pack	36	331 / 12.2 kWh	114.5 Kg (252.5 lb)

Type	Use	VDC	k W (hp)
Electric Motors	Main sweep brush	36	0.75 (1.00)
	Side sweep brush	36	0.12 (0.16)
	Vacuum fan	36	0.60 (8.00)
	Propelling	36	1.20 (1.60)
	Vacuum wand (Option)	36	0.71 (0.95)

Type	VDC	amp	Hz	Phase	VAC
Charger (On-Board)	36	25	50-60	1	100-240
Charger (On-Board)	36	33	50-60	1	100-240
Charger (Off-Board)	36	25	50-60	1	100-240
Charger, Lithium-Ion Battery (Off-Board)	36	33	50-60	1	100-240

TIRES

Location	Type	Size
Front (1)	Solid	102 mm wide x 300 mm OD (4 in wide x 12 in OD)
Rear (2)	Solid	102 mm wide x 300 mm OD (4 in wide x 12 in OD)

SPECIFICATIONS

MACHINE DIMENSIONS - LOW DUMP

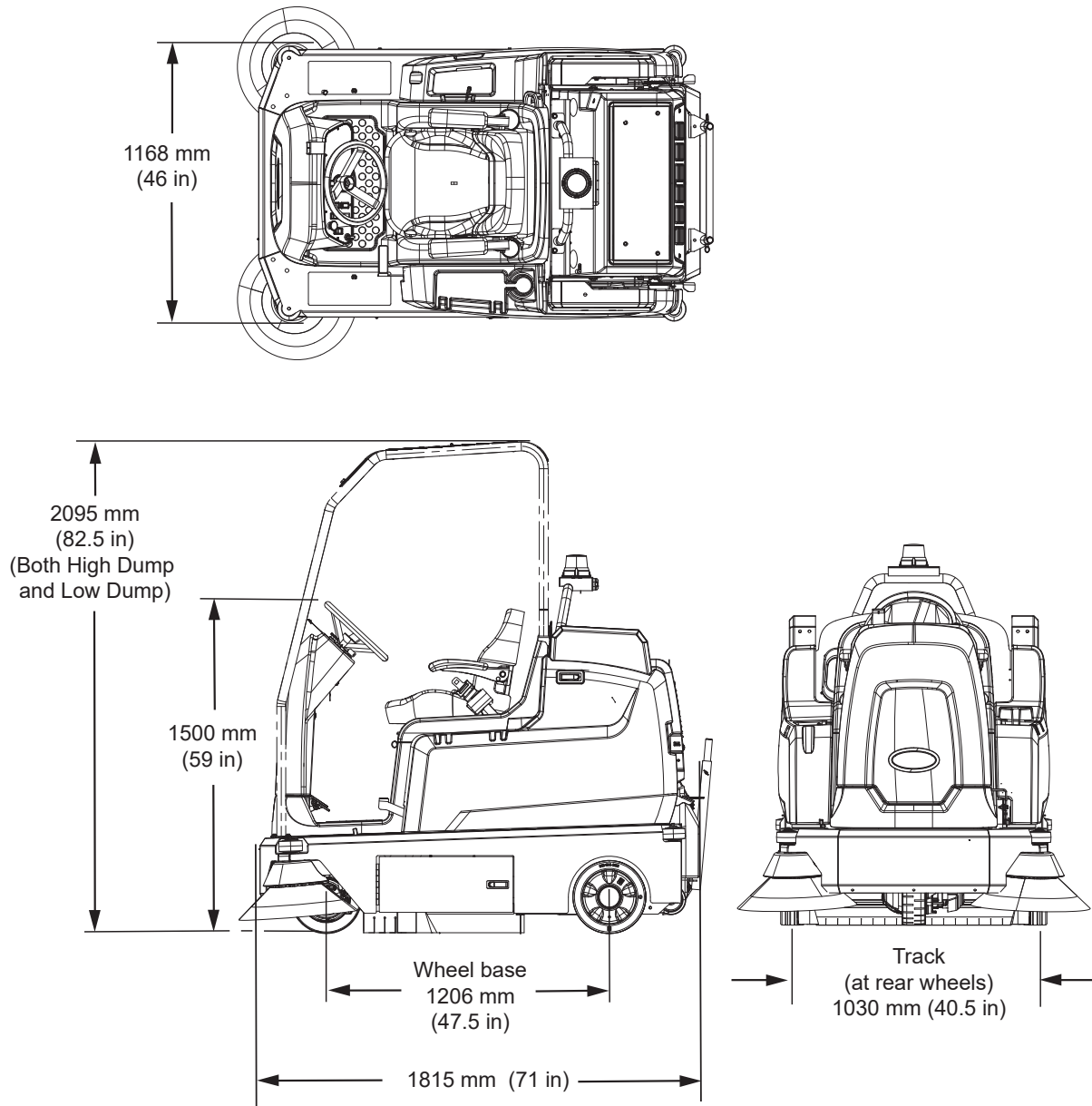

MACHINE DIMENSIONS - HIGH DUMP

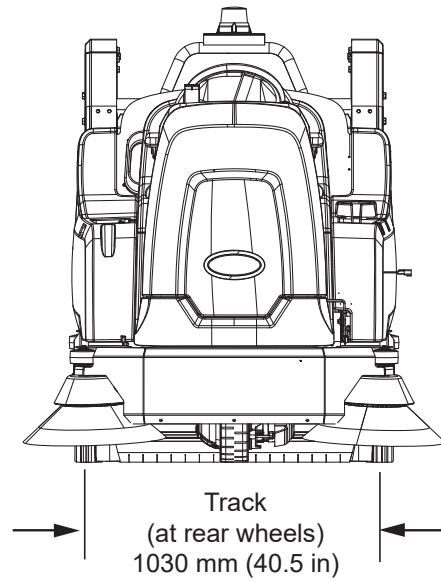
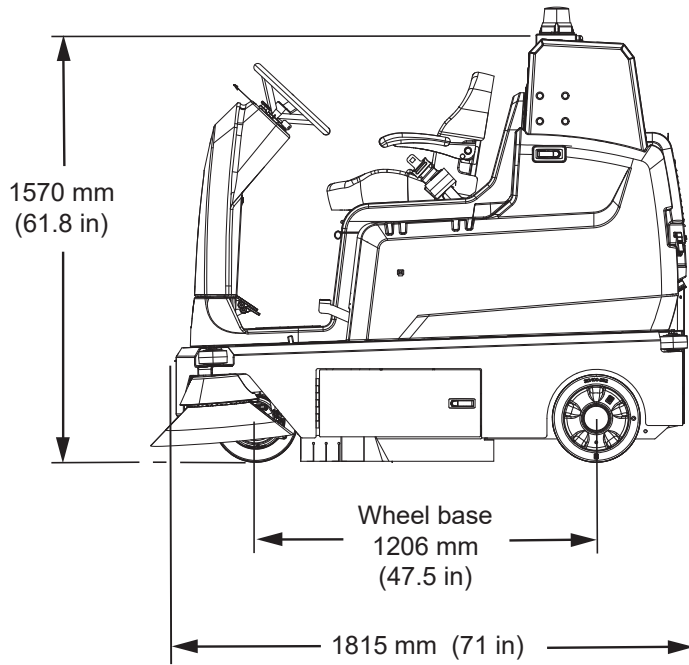
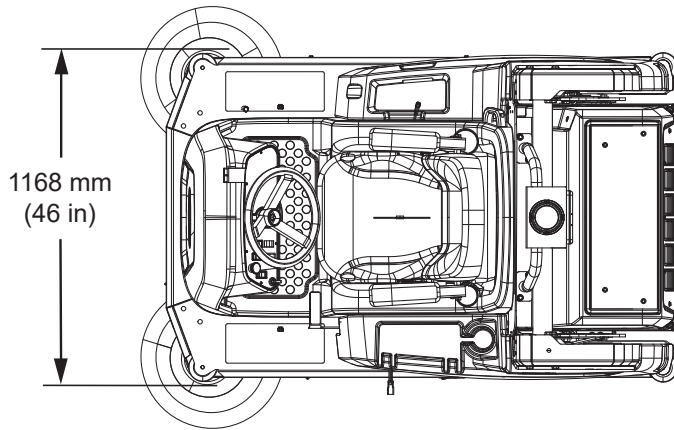

SUPERVISOR CONTROLS

SUPERVISOR CONTROLS

Use the supervisor controls to adjust both the maximum transport speed and the maximum sweep speed.

ENTERING THE SUPERVISOR MODE

1. Turn key switch OFF.
2. Press and hold the *Eco mode button*, and while continuing to hold the *Eco mode button*, turn and hold the key switch ON.



3. Continue holding the *Eco mode button* and the key switch to ON until both the *right side brush button indicator light* and *left side brush button indicator light* are flashing rapidly.

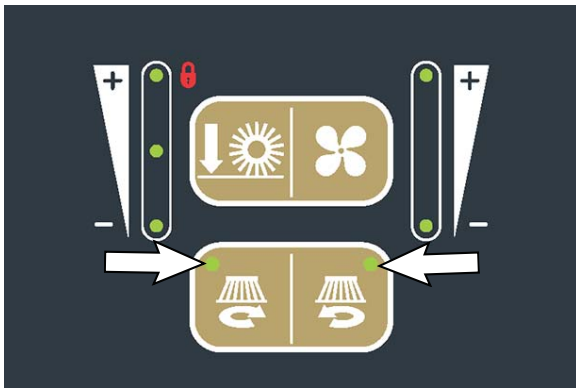

4. Release the key switch and *Eco mode button*.

NOTE: Propel is inoperable when the machine is in the Supervisor Mode. Continue making necessary changes, save changes, and exit the Supervisor Mode as instructed in the following steps to complete changes, or turn the key switch OFF to immediately exit the Supervisor Mode. No changes will be saved if Supervisor Mode is exited via turning key switch OFF.

5. Observe the *Eco mode button* indicator light and both side brush indicator lights. The *Eco mode button* indicator light must be illuminated (solid, not flashing) and the right side brush button indicator light and left side brush indicator light must be slowly flashing, indicating the machine is in the Supervisor Mode.

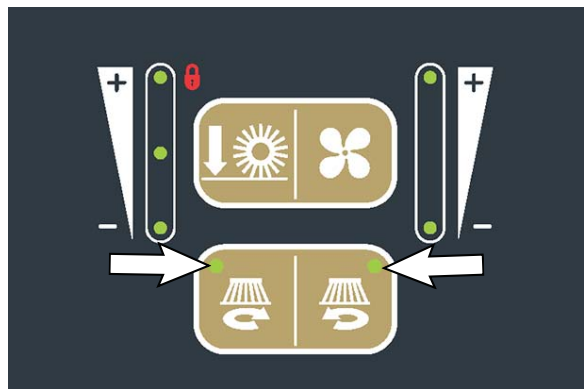

SUPERVISOR CONTROLS

CHANGING THE MACHINE SPEED

1. Enter the Supervisor Mode. See *ENTERING THE SUPERVISOR MODE*.
2. Observe the battery discharge indicator lights. The current machine speed is displayed via the flashing indicator light(s) on the battery discharge indicator.

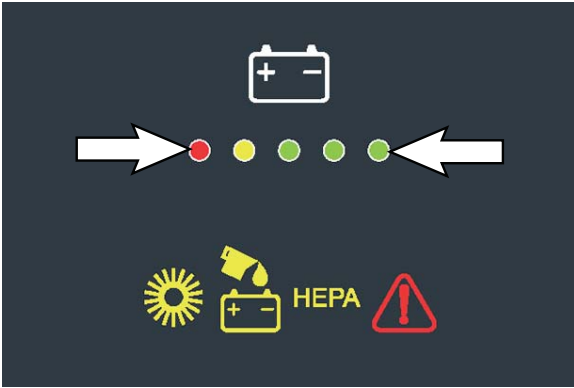

Indicator Light(s) Flashing	Miles Per Hour (MPH)
1 light	1 MPH
2 lights	2 MPH
3 lights	3 MPH
4 lights	4 MPH
5 lights	5.5 MPH

3. Press the *Eco mode button* to toggle between maximum sweep speed setting (battery indicator light(s) flashing slowly) and the maximum transport speed setting (battery indicator light(s) flashing rapidly).

4. Press the *left side brush button* to decrease the speed.

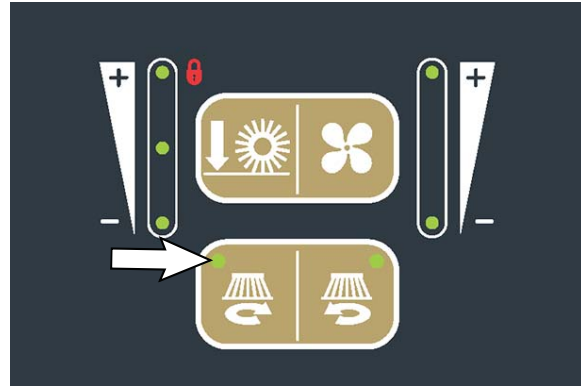

Press the *right side brush button* to increase the speed.

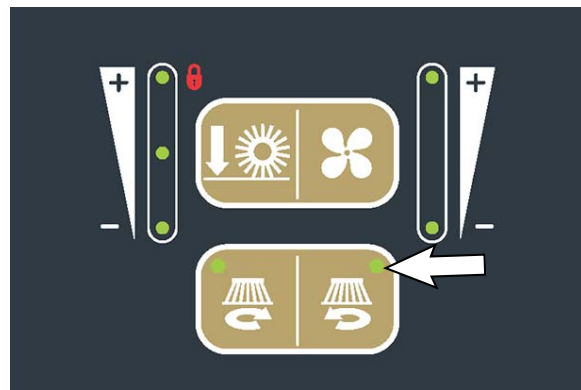

5. Press the *Eco mode button* to save the new speed settings. The changes will not be saved until the *Eco mode button* is pressed.
6. Turn key switch OFF to exit the Supervisor Mode.

Index

Symbols

1-Step Button, 18

A

Adjusting The Backup Alarm Volume (Option), 40
 Adjusting The Hopper Filter Cover Latches, 62
 Adjusting The Main Sweep Brush Pattern, 68
 Adjusting The Side Brush Pattern(s), 71
 Automatic Battery Watering Indicator (Option), 17
 Automatic Battery Watering System, 55

B

Batteries, 49
 Battery Compartment Drain, 56
 Charging The Batteries, 51
 Checking Connections/Cleaning, 50
 Checking The Electrolyte Level, 49
 Flooded (Wet) And Maintenance-Free Sealed Lead-Acid Batteries, 49
 Lithium-Ion Battery Pack, 50
 Maintenance-Free Batteries, 50
 Manual Battery Watering System, 54
 On-Board And Off-Board Battery Charger Settings, 52
 Opportunity Charging (Lithium-Ion Batteries Only), 53
 Smart-Fill Automatic Battery Watering System, 55
 Battery Compartment Drain, 56
 Battery Discharge Indicator, 17
 Belts, 75
 Main Brush Drive Belt, 75
 Blue Pedestrian Lights (Option), 39
 Brake Pedal, 22
 Brush Compartment HEPA Skirts (Option), 74
 Brush Information, 24
 Brush Pressure, 26
 Brush Wear Site, 65
 Buttons
 1-Step Button, 18
 Eco (Economy) Mode Button, 20
 Emergency Shut-Off Button, 21
 Filter Shaker Button, 20
 Hopper Safety Button, 19
 Left and Right Side Brush Buttons, 19
 Left Side Brush Button, 19
 Main Brush Pressure Button, 26
 Right Side Brush Button, 19
 Vacuum Fan Button, 19

C

Changing The Machine Speed, 88
 Charging The Batteries, 51
 Check Hydraulic Fluid Level (High Dump Machines Only), 48
 Checking Connections/Cleaning, Batteries, 50
 Checking The Electrolyte Level, Batteries, 49
 Checking The Main Sweep Brush Pattern, 67
 Checking The Side Brush Pattern(s), 70
 Checklist, Pre-Operation, 25
 Circuit Breakers, 57
 Circuit Breakers, Fuses, And Relays, 57
 Circuit Breakers, 57
 Fuses, 58
 Relays, 58
 Cleaning The High Dump Hopper, 59
 Cleaning The Hopper Dust Filter
 Machines Equipped With HEPA Filtration System, 61
 Machines Equipped With Standard Filtration System, 61
 Cleaning The Low Dump Hopper, 59
 Cleaning The Machine, 34
 Control Panels, 13
 Control Pedals, 14

D

Directional Switch, 21
 Disengaging The Hopper Support Bar (High Dump), 33
 Drain, Battery Compartment, 56

E

Eco (Economy) Mode Button, 20
 Electric Motors, 58
 Emergency Shut-Off Button, 21
 Emptying The Hopper, 29
 Emptying The Hopper (High Dump), 29
 Emptying The Hopper (Low Dump), 31
 Emptying The Hopper (High Dump), 29
 Emptying The Hopper (Low Dump), 31
 Engaging The Hopper Support Bar (High Dump), 33
 Entering The Supervisor Mode, 87
 Excessive Dusting (Troubleshooting), 41

F

Fault/Alert Codes And Indicators, 35
 Faults/Alerts Indicator Codes, 35
 Lithium-Ion Battery System Service Indicator Codes, 38
 Machine Service Indicator Codes, 36
 On-Board Battery Charger Indicator Codes, 37
 Fault Indicator, 18
 Filter Shaker Button, 20

Flooded (Wet) And Maintenance-Free Sealed
Lead-Acid Batteries, 49
Front-To-Back Adjustment Lever, 22
Fuses, 58

G

General Machine Dimensions/Capacities, 82
General Machine Performance, 83

H

HEPA Filter System Troubleshooting, 42
HEPA (High Efficiency Particulate Arrestance)
Filtration System (Option), 59
HEPA (High Efficiency Particulate Arrestance)
Indicator, 18
High Dump Machine Dimensions, 85
Hopper, 59
 Cleaning The High Dump Hopper, 59
 Cleaning The Low Dump Hopper, 59
Hopper Dust Filter, 60
 Adjusting The Hopper Filter Cover Latches, 62
 Cleaning The Hopper Dust Filter, 61
 Machines Equipped With HEPA Filtration Sys-
 tem, 61
 Machines Equipped With Standard Filtration
 System, 61
 Replacing The HEPA Filter, 63
 Thermo-Sentry, 62
Hopper Lift Arm Pivots, Lubrication, 47
Hopper Raise/Lower Switch, 29
Hopper Roll Switch, 29
Hopper Safety Button, 19
Hopper Seals, 74
Hour Meter, 18
How The Machine Works, 24
Hydraulic Fluid (High Dump Machines), 48
Hydraulic Hoses (High Dump Machines), 48
Hydraulic Reservoir (High Dump Machines), 48
Hydraulics (High Dump Machines), 48
 Check Hydraulic Fluid Level, 48
 Hydraulic Fluid, 48
 Hydraulic Hoses, 48
 Hydraulic Reservoir, 48
 Replace Hydraulic Fluid, 48

I

Indicators
 Automatic Battery Watering Indicator (Option), 17
 Battery Discharge Indicator, 17
 Fault Indicator, 18
 HEPA (High Efficiency Particulate Arrestance)
 Indicator, 18
 Worn Brush Indicator, 17
Installing Batteries, 16

J

Jacking Up The Machine, 79

L

Large Debris Flap Trap Pedal, 22
Large Debris Trap Skirt, 72
Left And Right Side Brush Buttons, 19
Left Side Brush Button, 19
Lithium-Ion Battery Pack, 50
Lithium-Ion Battery System Service Indicator
 Codes, 38
Low Dump Machine Dimensions, 84
Lubrication, 47
 Hopper Lift Arm Pivots, 47
 Steering Chain, 47

M

Machine Capacities, 82
Machine Components, 12
Machine Dimensions, 82
Machine Dimensions - High Dump, 85
Machine Dimensions - Low Dump, 84
Machine Jacking, 79
Machine Performance, 83
Machine Service Indicator Codes, 36
Machine Storage, 80
Machine Troubleshooting, 41
 Excessive Dusting, 41
 Poor Sweeping Performance, 41
 Poor Vacuum Wand Vacuum Performance, 41
 Reduced Run Time, 41
 Sweeping Functions Do Not Turn On, 41
Main Brush Door HEPA Seals (Option), 75
Main Brush Drive Belt, 75
Main Brush Pressure Button, 26
Main Sweep Brush, 65
 Adjusting The Main Sweep Brush Pattern, 68
 Brush Wear Site, 65
 Checking The Main Sweep Brush Pattern, 67
 Replacing The Main Sweep Brush, 65
Main Sweep Brush Pattern, Adjust, 68
Main Sweep Brush Pattern, Check, 67
Main Sweep Brush, Replace, 65
Maintenance Chart, 44
Maintenance-Free Batteries, 50
Manual Battery Watering System, 54
Motors, Electric, 58

O

- On-Board And Off-Board Battery Charger Settings, 52
- On-Board Battery Charger Indicator Codes, 37
- Operating/Hazard Light Switch (Option), 21
- Operation Of Controls, 17
 - 1-Step Button, 18
 - ABW (Smart-Fill Automatic Battery Watering) Indicator (Option), 17
 - Battery Discharge Indicator, 17
 - Brake Pedal, 22
 - Directional Switch, 21
 - Eco (Economy) Mode Button, 20
 - Emergency Shut-Off Button, 21
 - Fault Indicator, 18
 - Filter Shaker Button, 20
 - Front-To-Back Adjustment Lever, 22
 - HEPA (High Efficiency Particulate Arrestance) Indicator, 18
 - Hopper Safety Button, 19
 - Hour Meter, 18
 - Large Debris Flap Trap Pedal, 22
 - Left And Right Side Brush Buttons, 19
 - Left Side Brush Button, 19
 - Operating/Hazard Light Switch (Option), 21
 - Operator Seat Release Handle, 23
 - Propel Pedal, 22
 - Right Side Brush Button, 19
 - Seat Belts, 22
 - Seat Support, 23
 - Vacuum Fan Button, 19
 - Worn Brush Indicator, 17
- Operator Seat Release Handle, 23
- Opportunity Charging (Lithium-Ion Batteries Only), 53
- Options, 39
 - Adjusting The Backup Alarm Volume, 40
 - Blue Pedestrian Lights, 39
 - Vacuum Wand, 39
 - Replacing The Vacuum Wand Bag, 76

P

- Pedals
 - Brake Pedal, 22
 - Large Debris Flap Trap Pedal, 22
 - Propel Pedal, 22
- Poor Sweeping Performance (Troubleshooting), 41
- Poor Vacuum Wand Vacuum Performance (Troubleshooting), 41
- Power Type, 83
- Pre-Operation Checklist, 25
- Propel Pedal, 22

- Pushing Or Towing The Machine, 77
- Pushing, Towing, And Transporting The Machine, 77
 - Pushing Or Towing The Machine, 77
 - Transporting The Machine, 77

R

- Rear Recirculation Skirt, 73
- Rear Skirt, 73
- Reduced Run Time (Troubleshooting), 41
- Relays, 58
- Replace Hydraulic Fluid (High Dump Machines Only), 48
- Replacing The HEPA Filter, 63
- Replacing The Main Sweep Brush, 65
- Replacing The Side Brush(es), 69
- Replacing The Vacuum Wand Bag, 76
- Right Side Brush Button, 19

S

- Seals
 - Hopper Seals, 74
 - Main Brush Door Seals (Machines Equipped With HEPA Filtration System Option Only), 75
 - Vacuum Seal, 74
- Seat Belts, 22
- Seat Support, 23
- Setting The Main Brush Pressure, 26
- Side Brush Dust Control Skirts (Option), 73
- Side Brush(es), 69
 - Adjusting The Side Brush Pattern(s), 71
 - Checking The Side Brush Pattern(s), 70
 - Replacing The Side Brush(es), 69
- Side Recirculation Skirts, 73
- Side Skirts, 72
- Skirts
 - Brush Compartment Skirts (Machines Equipped With HEPA Filtration System Option Only), 74
 - Large Debris Trap Skirt, 72
 - Rear Recirculation Skirt, 73
 - Rear Skirt, 73
 - Side Brush Dust Control Skirts (Option), 73
 - Side Recirculation Skirts, 73
 - Side Skirts, 72
 - Sweep Compartment HEPA Side Skirts (Machines Equipped With HEPA Filtration System Option Only), 72, 74

Skirts And Seals, 72
 Brush Compartment Skirts (Machines Equipped
 With HEPA Filtration System Option Only),
 74
 Hopper Seals, 74
 Large Debris Trap Skirt, 72
 Main Brush Door Seals (Machines Equipped
 With HEPA Filtration System Option Only),
 75
 Rear Recirculation Skirt, 73
 Rear Skirt, 73
 Side Brush Dust Control Skirts (Option), 73
 Side Recirculation Skirts, 73
 Side Skirts, 72
 Sweep Compartment Side Skirts (Machines
 Equipped With HEPA Filtration System Op-
 tion Only), 72, 74
 Vacuum Seals, 74
Specifications, 82
 General Machine Dimensions/Capacities, 82
 General Machine Performance, 83
 Power Type, 83
 Tires, 83
Steering Chain, Lubrication, 47
Stop Sweeping, 28
Storage Information, 80
Supervisor Controls, 87
 Changing The Machine Speed, 88
 Entering The Supervisor Mode, 87
Sweeping, 27
Sweeping Functions Do Not Turn On (Trouble-
 shooting), 41
Switches
 Directional Switch, 21
 Hopper Raise/Lower Switch, 29
 Hopper Roll Switch, 29
 Operating/Hazard Light Switch (Option), 21
Symbol Definition, 15

T

Thermo-Sentry, 62
Tires, 75
Transporting The Machine, 77
Turning Off The Machine, 34
Turning On The Machine, 26

V

Vacuum Fan Button, 19
Vacuum Seals, 74
Vacuum Wand Maintenance (Option), 39, 75
 Replacing The Vacuum Wand Bag, 76
 Vacuum Wand Fan, 75
Vacuum Wand (Option), 39

W

While Operating The Machine, 25
Worn Brush Indicator, 17

Y

Yellow Touch Points, 47